

# STABILIZER

Digital Display

High Precision

Energy Efficient



Best Quality

Engineered with precision and professionalism, our Servo and Relay stabilizers redefine trust in voltage regulation. Experience unwavering reliability and cutting-edge technology with Arakawa, where your power is our priority.



Best Service

# TABLE OF CONTENT

<b>01</b>	<b>ZY Type</b>	48	ARS-TMN	<b>89</b>	<b>SERVO Type</b>
02	ARS-ZY95-D	49	ARS-TMQ	90	ARS-SVC-PC
05	ARS-ZY95-U	50	ARS-TME	91	ARS-TVC
10	ARS-ZY95-N	52	ARS-SMB	95	ARS-PC-SVC
13	ARS-ZY95-A	56	ARS-TMO95	96	ARS-PC-SVC-A
17	ARS-ZY95-H	57	ARS-TMS	97	ARS-F Series
18	ARS-ZMA95	60	ARS-TMH-A	99	ARS-SVC50
20	ARS-ZMA-K	61	ARS-COC	100	ARS-SVC-M
21	ARS-ZMB95	65	ARS-CLS	102	ARS-SVC-X
		67	ARS-SSS	103	ARS-SVC-H
<b>23</b>	<b>RELAY Type</b>	70	ARS-SAE	104	ARS-TAD
24	ARS-TAC95	73	ARS-SAB	105	ARS-TCD
25	ARS-TAB95	74	ARS-TMJ	106	ARS-TCD-A
26	ARS-TMU	75	ARS-SVB	107	ARS-TND
30	ARS-TMB	77	ARS-SVE	109	ARS-TND-A
34	ARS-TM	79	ARS-SVR	110	ARS-P Series
35	ARS-MOD	81	ARS-SVF	111	ARS-TNS-C
38	ARS-TMP	82	ARS-TML	113	ARS-TNS-U
41	ARS-MOU95	84	ARS-TMG	115	ARS-TNSB
42	ARS-MOU	85	ARS-TMG-A	116	ARS-TNSB-A
45	ARS-MON	86	ARS-TMH	117	ARS-TNSB-U
				118	ARS-PD Series
				120	<b>CUSTOM PART</b>

**ARAKAWA STABILIZER**  
Digital Display



# ZY TYPE

The product of this type is a **220V** fully automatic voltage regulator, both for desktop & wall mounted. With LED Digital Display design. It is characterized by stable work, high pressure regulation speed and wide voltage regulation range.

ISO9001



NORMAL



DELAY



LOW VOL



OVER VOL



OVER LOAD

# ARS-ZY95-D

Series

(3000VA - 10KVA)



ISO9001



The product of this model is a **220V** fully automatic voltage regulator, both for desktop & wall mounted. With LED Digital Display design. It is characterized by stable work, high pressure regulation speed and wide voltage regulation range.

## TECHNICAL DATA

MODEL	ARS-ZY95-D-3000VA	ARS-ZY95-D-5000VA
INPUT VOLTAGE	AC 95V-270V	
OUTPUT VOLTAGE	AC 220V±10% 50/60Hz	
DELAY TIME	Short Delay:3-5sec Long delay:3-7min	
PROTECTION	Over Voltage(246V±4V),Overload,High Temperature,Short Circuit	
POWER	3000VA	5000VA
PRODUCT SIZE(CM)	39x24.5x10	39x24.5x10
PACKING SIZE(CM)	44x29.5x15.3	44x29.5x15.3
PCS/CARTON	1	1
N.W.(KG)	8	11.3
G.W.(KG)	8.4	11.8

LED Display



Switch Button



## TECHNICAL DATA

MODEL	ARS-ZY95-D-8000VA	ARS-ZY95-D-10KVA
INPUT VOLTAGE	AC 95V-270V	
OUTPUT VOLTAGE	AC 220V±10% 50/60Hz	
DELAY TIME	Short Delay:3-5sec Long delay:3-7min	
PROTECTION	Over Voltage(246V±4V),Overload,High Temperature,Short Circuit	
POWER	8000VA	10000VA
PRODUCT SIZE(CM)	41x29.5x15	41x29.5x15
PACKING SIZE(CM)	46x34.5x21	46x34.5x21
PCS/CARTON	1	1
N.W.(KG)	17.6	20.1
G.W.(KG)	18.5	21

● ● ●  
Widely used in various industries, small office equipment, refrigerator, electric fan, computer, pump, air conditioner, etc.



Washing Maching Fridge Air Conditioner Air compressor Motor Water pump

Relay Control + Toroidal Transformer, Efficiency > 97%

# ARS-ZY95-D

Series

(12KVA-15KVA)



ISO9001



The product of this model is a **220V** fully automatic voltage regulator, both for desktop & wall mounted. With LED Digital Display design. It is characterized by stable work, high pressure regulation speed and wide voltage regulation range.

## TECHNICAL DATA

MODEL	ARS-ZY95-D-12KVA	ARS-ZY95-D-15KVA
INPUT VOLTAGE	AC 95V-270V	
OUTPUT VOLTAGE	AC 220V±10% 50/60Hz	
DELAY TIME	Short Delay:3-5sec Long Deley:3-7min	
PROTECTION	Over Voltage(246V±4V),Overload,High Temperature,Short Circuit	
POWER	12KVA	15KVA
PRODUCT SIZE(CM)	45x31.5x16.4	45x31.5x16.4
PACKING SIZE(CM)	51.8x38.5x23.7	51.8x38.5x23.7
PCS/CARTON	1	1
N.W.(KG)	22.1	25
G.W.(KG)	23.1	26

LED Display



Switch Button



Screen cover

LED-3L

Metal panel

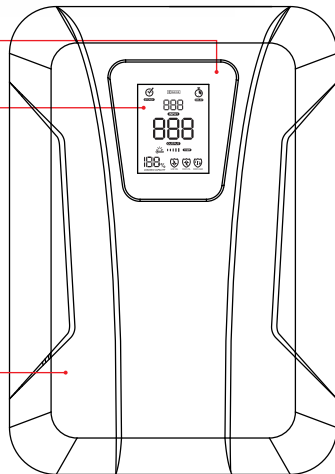

## TECHNICAL DRAWING

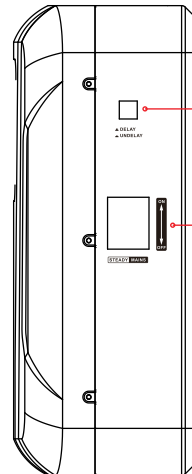

Delay button

Air switch

Widely used in various industries, small office equipment, refrigerator, electric fan, computer, pump, air conditioner, etc.



Washing Maching    LCD TV    Rice Cooker    Microwave Oven    Printer    Computer

Relay Control + Toroidal Transformer, Efficiency > 97%

# ARS-ZY95-D

Series (20KVA)



ISO9001



The product of this model is a **220V** fully automatic voltage regulator, both for desktop & wall mounted. With LED Digital Display design. It is characterized by stable work, high pressure regulation speed and wide voltage regulation range.

## TECHNICAL DATA

MODEL	ARS-ZY95-D-20KVA
INPUT VOLTAGE	AC 95V-270V
OUTPUT VOLTAGE	AC 220V±10% 50/60Hz
DELAY TIME	Short Delay:3-5sec Long delay:3-7min
PROTECTION	Over Voltage(246V±4V),Overload,High Temperature,Short Circuit
POWER	20KVA
PRODUCT SIZE(CM)	45x31.5x17.4
PACKING SIZE(CM)	51.8x38.5x24.7
PCS/CARTON	1
N.W.(KG)	28
G.W.(KG)	29.1

LED Display



Switch Button



Screen cover

LED-3L

Metal panel

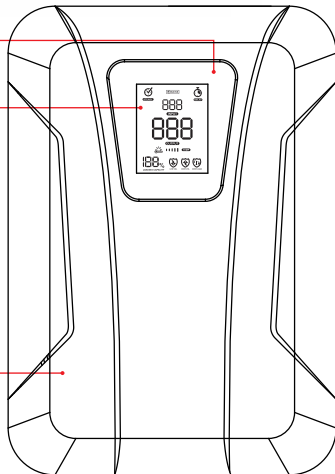

## TECHNICAL DRAWING

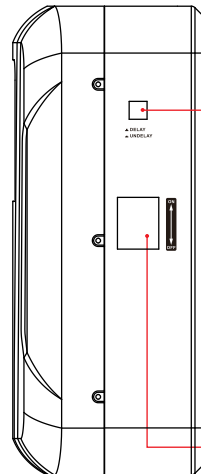

Delay button

Air switch

Widely used in various industries, small office equipment, refrigerator, electric fan, computer, pump, air conditioner, etc.



Washing Maching Fridge Air Conditioner Air compressor Motor Water pump

Relay Control + Toroidal Transformer, Efficiency > 97%

# ARS-ZY95-U

Series

(3000VA - 10KVA)



ISO9001



The product of this model is a **220V** fully automatic voltage regulator, both for desktop & wall mounted. With LED Digital Display design. It is characterized by stable work, high pressure regulation speed and wide voltage regulation range.

## TECHNICAL DATA

MODEL	ARS-ZY95-U-3000VA	ARS-ZY95-U-5000VA
INPUT VOLTAGE	AC 95V-270V	
OUTPUT VOLTAGE	AC 220V±10% 50/60Hz	
DELAY TIME	Short Delay:3-5sec Long delay:3-7min	
PROTECTION	Over Voltage(246V±4V),Overload,High Temperature,Short Circuit	
POWER	3000VA	5000VA
PRODUCT SIZE(CM)	39x24.5x10	39x24.5x10
PACKING SIZE(CM)	44x29.5x15.3	44x29.5x15.3
PCS/CARTON	1	1
N.W.(KG)	8	11.3
G.W.(KG)	8.4	11.8

LED Display



Switch Button



## TECHNICAL DATA

MODEL	ARS-ZY95-U-8KVA	ARS-ZY95-U-10KVA
INPUT VOLTAGE	AC 95V-270V	
OUTPUT VOLTAGE	AC 220V±10% 50/60Hz	
DELAY TIME	Short Delay:3-5sec Long delay:3-7min	
PROTECTION	Over Voltage(246V±4V),Overload,High Temperature,Short Circuit	
POWER	8000VA	10000VA
PRODUCT SIZE(CM)	41x29.5x15	41x29.5x15
PACKING SIZE(CM)	46x34.5x22	46x34.5x22
PCS/CARTON	1	1
N.W.(KG)	17.6	20.1
G.W.(KG)	18.5	21

● ● ●  
Widely used in various industries, small office equipment, refrigerator, electric fan, computer, pump, air conditioner, etc.



Washing Maching    LCD TV    Rice Cooker    Microwave Oven    Printer    Computer

Relay Control + Toroidal Transformer, Efficiency > 97%

# ARS-ZY95-U

Series

(12KVA - 15KVA)



ISO9001



The product of this model is a **220V** fully automatic voltage regulator, both for desktop & wall mounted. With LED Digital Display design. It is characterized by stable work, high pressure regulation speed and wide voltage regulation range.

## TECHNICAL DATA

MODEL	ARS-ZY95-U-12KVA	ARS-ZY95-U-15KVA
INPUT VOLTAGE	AC 95V-270V	
OUTPUT VOLTAGE	AC 220V±10% 50/60Hz	
DELAY TIME	Short Delay:3-5sec Long Delay:3-7min	
PROTECTION	Over Voltage(246V±4V),Overload,High Temperature,Short Circuit	
POWER	12KVA	15KVA
PRODUCT SIZE(CM)	45x31.5x16.4	45x31.5x16.4
PACKING SIZE(CM)	51.8x38.5x23.7	51.8x38.5x23.7
PCS/CARTON	1	1
N.W.(KG)	22.1	25
G.W.(KG)	23.1	26

LED Display



Switch Button



Screen cover

LED-3G

Metal panel

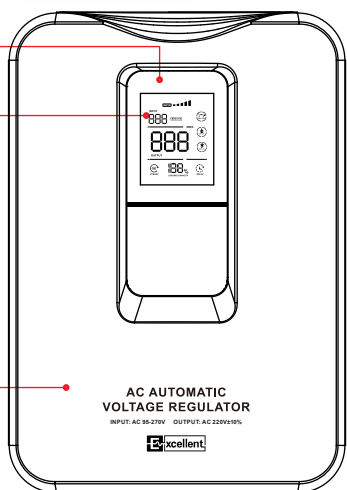

## TECHNICAL DRAWING

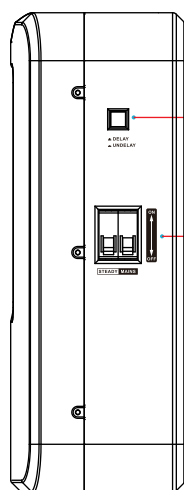

Delay button

Air switch

Widely used in various industries, small office equipment, refrigerator, electric fan, computer, pump, air conditioner, etc.



Washing Maching Fridge Air Conditioner Air compressor Motor Water pump

Relay Control + Toroidal Transformer, Efficiency > 97%



# ARS-ZY95-U

Series (20KVA)



ISO9001



The product of this model is a **220V** fully automatic voltage regulator, both for desktop & wall mounted. With LED Digital Display design. It is characterized by stable work, high pressure regulation speed and wide voltage regulation range.

## TECHNICAL DATA

MODEL	ARS-ZY95-U-20KVA
INPUT VOLTAGE	AC 95V-270V
OUTPUT VOLTAGE	AC 220V±10% 50/60Hz
DELAY TIME	Short Delay:3-5sec Long delay:3-7min
PROTECTION	Over Voltage(246V±4V),Overload,High Temperature,Short Circuit
POWER	20KVA
PRODUCT SIZE(CM)	45x31.5x17.4
PACKING SIZE(CM)	51.8x38.5x24.7
PCS/CARTON	1
N.W.(KG)	28
G.W.(KG)	29.1

LED Display



Switch Button



Screen cover

LED-3G

Metal panel

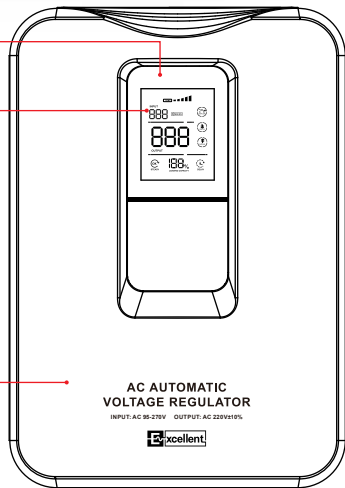

## TECHNICAL DRAWING

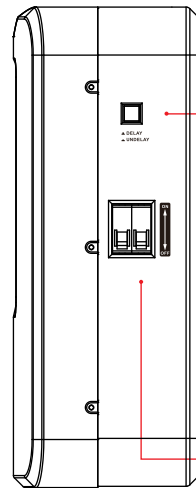

Delay button

Air switch

Widely used in various industries, small office equipment, refrigerator, electric fan, computer, pump, air conditioner, etc.



Washing Maching LCD TV Rice Cooker Microwave Oven Printer Computer

Relay Control + Toroidal Transformer, Efficiency > 97%

# ARS-ZY95-U

Series (25KVA)



ISO9001



The product of this model is a **220V** fully automatic voltage regulator, both for desktop & wall mounted. With LED Digital Display design. It is characterized by stable work, high pressure regulation speed and wide voltage regulation range.

## TECHNICAL DATA

MODEL	ARS-ZY95-U-25KVA
INPUT VOLTAGE	AC 95V-270V
OUTPUT VOLTAGE	AC 220V±10% 50/60Hz
DELAY TIME	Short Delay:3-5sec Long delay:3-7min
PROTECTION	Over Voltage(246V±4V),Overload,High Temperature,Short Circuit
POWER	25KVA
PRODUCT SIZE(CM)	42.3x37.5x27.4
PACKING SIZE(CM)	43x47.8x36.5
PCS/CARTON	1
N.W.(KG)	39.3
G.W.(KG)	44.3

LED Display



Switch Button



Metal panel

LED-3L

Screen cover

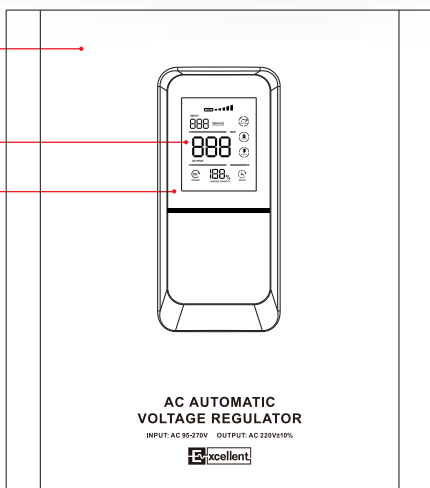

## TECHNICAL DRAWING

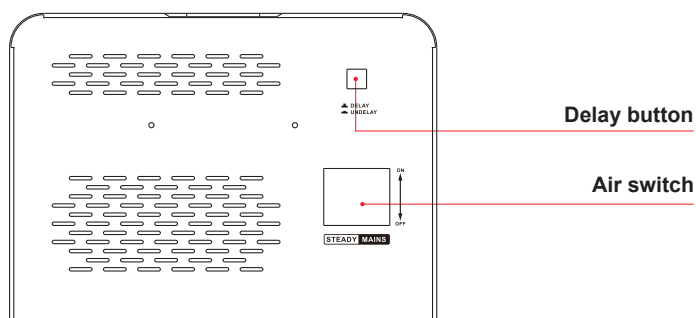

Widely used in various industries, small office equipment, refrigerator, electric fan, computer, pump, air conditioner, etc.



Relay Control + Toroidal Transformer, Efficiency > 97%

# ARS-ZY95-U

Series (30KVA)



ISO9001



The product of this model is a **220V** fully automatic voltage regulator, both for desktop & wall mounted. With LED Digital Display design. It is characterized by stable work, high pressure regulation speed and wide voltage regulation range.

## TECHNICAL DATA

MODEL	ARS-ZY95-U-30KVA
INPUT VOLTAGE	AC 95V-270V
OUTPUT VOLTAGE	AC 220V±10% 50/60Hz
DELAY TIME	Short Delay:3-5sec Long delay:3-7min
PROTECTION	Over Voltage(246V±4V),Overload,High Temperature,Short Circuit
POWER	30KVA
PRODUCT SIZE(CM)	34.5x44x42
PACKING SIZE(CM)	40x49.5x57
PCS/CARTON	1
N.W.(KG)	40.5
G.W.(KG)	48.5

LED Display



Switch Button



Metal panel

LED-3L

Screen cover

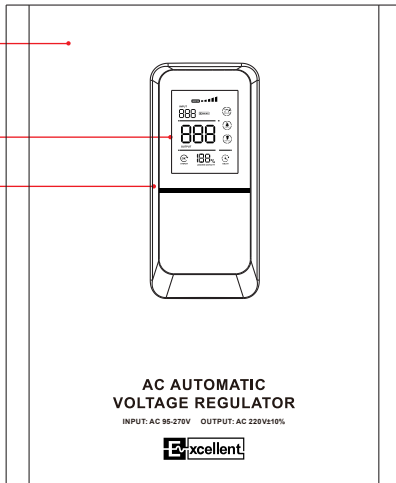

TECHNICAL DRAWING

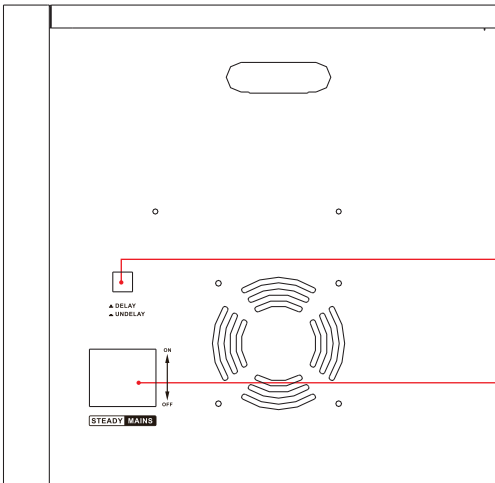

Delay button

Air switch

Widely used in various industries, small office equipment, refrigerator, electric fan, computer, pump, air conditioner, etc.



Washing Maching LCD TV Rice Cooker Microwave Oven Printer Computer

Relay Control + Toroidal Transformer, Efficiency > 97%

# ARS-ZY95-N

Series

(3KVA - 10KVA)



ISO9001



The product of this model is a **220V** fully automatic voltage regulator, both for desktop & wall mounted. With LED Digital Display design. It is characterized by stable work, high pressure regulation speed and wide voltage regulation range.

## TECHNICAL DATA

MODEL	ARS-ZY95-N-3000VA	ARS-ZY95-N-5000VA
INPUT VOLTAGE	AC 95V-270V	
OUTPUT VOLTAGE	AC 220V±10% 50/60Hz	
DELAY TIME	Short Delay:3-5sec Long delay:3-7min	
PROTECTION	Over Voltage(246V±4V),Overload,High Temperature,Short Circuit	
POWER	3000VA	5000VA
PRODUCT SIZE(CM)	39x24.5x10	39x24.5x10
PACKING SIZE(CM)	44x29.5x15.3	44x29.5x15.3
PCS/CARTON	1	1
N.W.(KG)	8	11.3
G.W.(KG)	8.4	11.8

LED Display



Switch Button



## TECHNICAL DATA

MODEL	ARS-ZY95-N-8KVA	ARS-ZY95-N-10KVA
INPUT VOLTAGE	AC 95V-270V	
OUTPUT VOLTAGE	AC 220V±10% 50/60Hz	
DELAY TIME	Short Delay:3-5sec Long delay:3-7min	
PROTECTION	Over Voltage(246V±4V),Overload,High Temperature,Short Circuit	
POWER	8000VA	10000VA
PRODUCT SIZE(CM)	41x29.5x15	41x29.5x15
PACKING SIZE(CM)	46x34.5x21	46x34.5x21
PCS/CARTON	1	1
N.W.(KG)	17.6	20.1
G.W.(KG)	18.5	21

Widely used in various industries, small office equipment, refrigerator, electric fan, computer, pump, air conditioner, etc.



Washing Maching Fridge Air Conditioner Air compressor Motor Water pump

Relay Control + Toroidal Transformer, Efficiency > 97%

# ARS-ZY95-N

Series

(12KVA - 15KVA)



ISO9001



The product of this model is a **220V** fully automatic voltage regulator, both for desktop & wall mounted. With LED Digital Display design. It is characterized by stable work, high pressure regulation speed and wide voltage regulation range.

## TECHNICAL DATA

MODEL	ARS-ZY95-N-12KVA	ARS-ZY95-N-15KVA
INPUT VOLTAGE	AC 95V-270V	
OUTPUT VOLTAGE	AC 220V±10% 50/60Hz	
DELAY TIME	Short Delay:3-5sec Long Delay:3-7min	
PROTECTION	Over Voltage(246V±4V),Overload,High Temperature,Short Circuit	
POWER	12KVA	15KVA
PRODUCT SIZE(CM)	45x31.5x16.4	45x31.5x16.4
PACKING SIZE(CM)	51.8x38.5x23.7	51.8x38.5x23.7
PCS/CARTON	1	1
N.W.(KG)	22.1	25
G.W.(KG)	23.1	26

LED Display



Switch Button



Screen cover

LED-3L

Metal panel

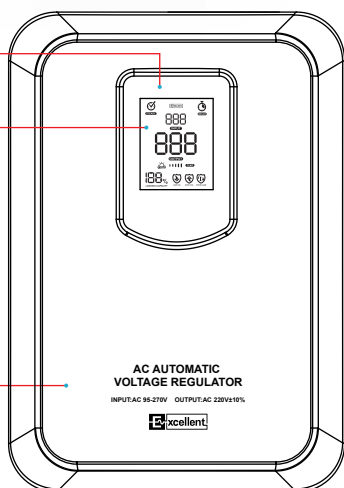

## TECHNICAL DRAWING

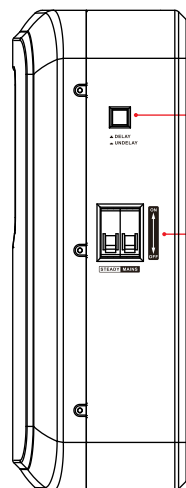

Delay button

Air switch

Widely used in various industries, small office equipment, refrigerator, electric fan, computer, pump, air conditioner, etc.



Washing Maching    LCD TV    Rice Cooker    Microwave Oven    Printer    Computer

Relay Control + Toroidal Transformer, Efficiency > 97%

# ARS-ZY95-N

Series (20KVA)



ISO9001



The product of this model is a **220V** fully automatic voltage regulator, both for desktop & wall mounted. With LED Digital Display design. It is characterized by stable work, high pressure regulation speed and wide voltage regulation range.

## TECHNICAL DATA

MODEL	ARS-ZY95-N-20KVA
INPUT VOLTAGE	AC 95V-270V
OUTPUT VOLTAGE	AC 220V±10% 50/60Hz
DELAY TIME	Short Delay:3-5sec Long delay:3-7min
PROTECTION	Over Voltage(246V±4V),Overload,High Temperature,Short Circuit
POWER	20KVA
PRODUCT SIZE(CM)	45x31.5x17.4
PACKING SIZE(CM)	51.8x38.5x24.7
PCS/CARTON	1
N.W.(KG)	28
G.W.(KG)	29.1

LED Display



Switch Button



Screen cover

LED-3L

Metal panel

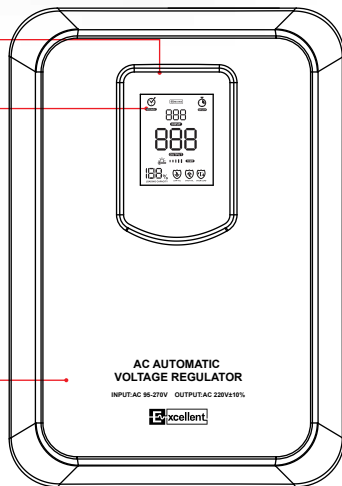

## TECHNICAL DRAWING

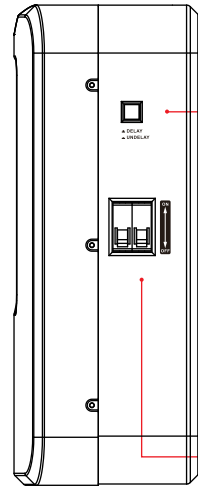

Delay button

Air switch

Widely used in various industries, small office equipment, refrigerator, electric fan, computer, pump, air conditioner, etc.



Washing Maching Fridge Air Conditioner Air compressor Motor Water pump

Relay Control + Toroidal Transformer, Efficiency > 97%

# ARS-ZY95-A

Series

(3KVA - 10KVA)



ISO9001



The product of this model is a **220V** fully automatic voltage regulator, both for desktop & wall mounted. With LED Digital Display design. It is characterized by stable work, high pressure regulation speed and wide voltage regulation range.

## TECHNICAL DATA

MODEL	ARS-ZY95-A-3000VA	ARS-ZY95-A-5000VA
INPUT VOLTAGE	AC 95V-270V	
OUTPUT VOLTAGE	AC 220V±10% 50/60Hz	
DELAY TIME	Short Delay:3-5sec Long delay:3-7min	
PROTECTION	Over Voltage(246V±4V),Overload,High Temperature,Short Circuit	
POWER	3000VA	5000VA
PRODUCT SIZE(CM)	33x22x12.9	33x22x12.9
PACKING SIZE(CM)	38x27x18.5	38x27x18.5
PCS/CARTON	1	1
N.W.(KG)	8.3	11
G.W.(KG)	8.7	11.4

LED Display



Switch Button



## TECHNICAL DATA

MODEL	ARS-ZY95-A-8KVA	ARS-ZY95-A-10KVA
INPUT VOLTAGE	AC 95V-270V	
OUTPUT VOLTAGE	AC 220V±10% 50/60Hz	
DELAY TIME	Short Delay:3-5sec Long delay:3-7min	
PROTECTION	Over Voltage(246V±4V),Overload,High Temperature,Short Circuit	
POWER	8000VA	10000VA
PRODUCT SIZE(CM)	40.8x27x15	40.8x27x15
PACKING SIZE(CM)	45.8x32x21	45.8x32x21
PCS/CARTON	1	1
N.W.(KG)	15.6	18.1
G.W.(KG)	16.1	18.6

● ● ●  
Widely used in various industries, small office equipment, refrigerator, electric fan, computer, pump, air conditioner, etc.



Washing Maching    LCD TV    Rice Cooker    Microwave Oven    Printer    Computer

Relay Control + Toroidal Transformer, Efficiency > 97%

# ARS-ZY95-A

Series

(12KVA - 20KVA)



ISO9001



The product of this model is a **220V** fully automatic voltage regulator, both for desktop & wall mounted. With LED Digital Display design. It is characterized by stable work, high pressure regulation speed and wide voltage regulation range.

## TECHNICAL DATA

MODEL	ARS-ZY95-A-12KVA	ARS-ZY95-A-15KVA	ARS-ZY95-A-20KVA
INPUT VOLTAGE	AC 95V-270V		
OUTPUT VOLTAGE	AC 220V±10% 50/60Hz		
DELAY TIME	Short Delay:3-5sec Long Delay:3-7min		
PROTECTION	Over Voltage(246V±4V),Overload,High Temperature,Short Circuit		
POWER	12KVA	15KVA	20KVA
PRODUCT SIZE(CM)	42.8x27x16	42.8x27x16	43.1x27x17
PACKING SIZE(CM)	47.8x32x22	47.8x32x22	48x32x23
PCS/CARTON	1	1	1
N.W.(KG)	19.5	22.8	24.6
G.W.(KG)	20.5	23.8	26

LED Display



Switch Button



Screen cover

LED-3L

Metal panel

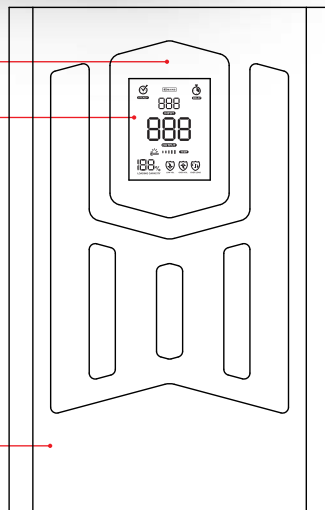

## TECHNICAL DRAWING

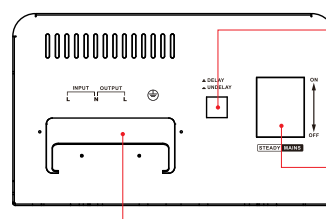

Delay button

Air switch

Terminal block

Widely used in various industries, small office equipment, refrigerator, electric fan, computer, pump, air conditioner, etc.



Washing Maching Fridge Air Conditioner Air compressor Motor Water pump

Relay Control + Toroidal Transformer, Efficiency > 97%



# ARS-ZY95-A

Series (25KVA)



ISO9001



The product of this model is a **220V** fully automatic voltage regulator, both for desktop & wall mounted. With LED Digital Display design. It is characterized by stable work, high pressure regulation speed and wide voltage regulation range.

## TECHNICAL DATA

MODEL	ARS-ZY95-A-25KVA
INPUT VOLTAGE	AC 95V-270V
OUTPUT VOLTAGE	AC 220V±10% 50/60Hz
DELAY TIME	Short Delay:3-5sec Long delay:3-7min
PROTECTION	Over Voltage(246V±4V),Overload,High Temperature,Short Circuit
POWER	25KVA
PRODUCT SIZE(CM)	42.3x37.5x27.4
PACKING SIZE(CM)	43x47.8x36.5
PCS/CARTON	1
N.W.(KG)	39.3
G.W.(KG)	44.3

LED Display



Switch Button



Metal panel

LED-3L

Screen cover

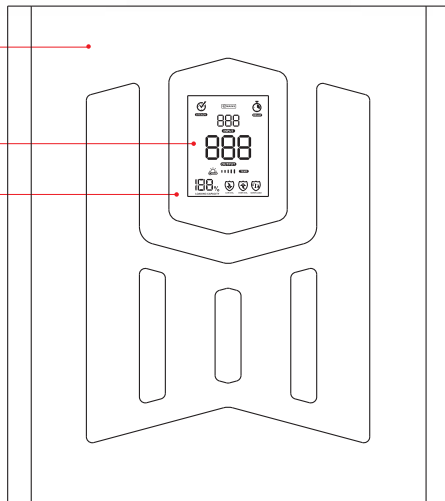

## TECHNICAL DRAWING

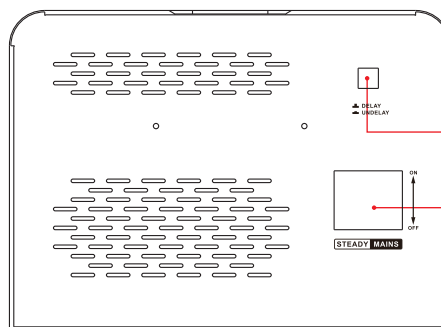

Delay button

Air switch

Widely used in various industries, small office equipment, refrigerator, electric fan, computer, pump, air conditioner, etc.



Washing Maching LCD TV Rice Cooker Microwave Oven Printer Computer

Relay Control + Toroidal Transformer, Efficiency > 97%

# ARS-ZY95-A

Series (30KVA)



ISO9001



The product of this model is a **220V** fully automatic voltage regulator, both for desktop & wall mounted. With LED Digital Display design. It is characterized by stable work, high pressure regulation speed and wide voltage regulation range.

## TECHNICAL DATA

MODEL	ARS-ZY95-A-30KVA
INPUT VOLTAGE	AC 95V-270V
OUTPUT VOLTAGE	AC 220V±10% 50/60Hz
DELAY TIME	Short Delay:3-5sec Long delay:3-7min
PROTECTION	Over Voltage(246V±4V),Overload,High Temperature,Short Circuit
POWER	30KVA
PRODUCT SIZE(CM)	34.5x44x42
PACKING SIZE(CM)	40x49.5x57
PCS/CARTON	1
N.W.(KG)	40.5
G.W.(KG)	48.5

LED Display



Switch Button



Metal panel

LED-3L

Screen cover

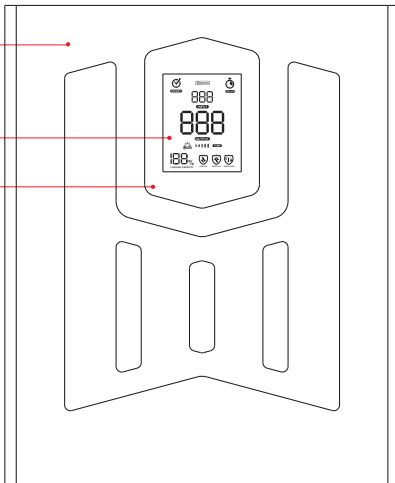

TECHNICAL DRAWING

Delay button

Air switch

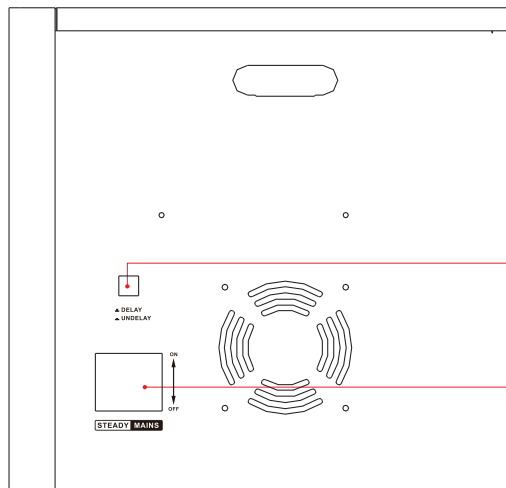

Widely used in various industries, small office equipment, refrigerator, electric fan, computer, pump, air conditioner, etc.



Washing Maching Fridge Air Conditioner Air compressor Motor Water pump

Relay Control + Toroidal Transformer, Efficiency > 97%

# ARS-ZY95-H

Series (25KVA)



ISO9001



The product of this model is a **220V** fully automatic voltage regulator, design of LCD Digital Display and easy move. It is characterized by stable work, high pressure regulation speed and wide voltage regulation range.

## TECHNICAL DATA

MODEL	ARS-ZY95-H-25KVA
INPUT VOLTAGE	AC 95V-270V
OUTPUT VOITAGE	AC 220V±10% 50/60Hz
DELAY TIME	Short Delay:3-5sec
PROTECTION	Over Voltage(246V±4V),Overload,High Temperature,Short Circuit
POWER	25000VA
PRODUCT SIZE(CM)	35x40x40
PACKING SIZE(CM)	41.5x47.5x55
PCS/CARTON	1
N.W.(KG)	40.5
G.W.(KG)	48.5

LED Display



Switch Button



Screen sticker

LED-2B

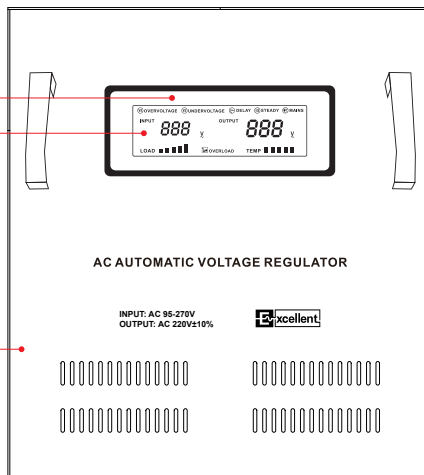

Metal panel

TECHNICAL DRAWING

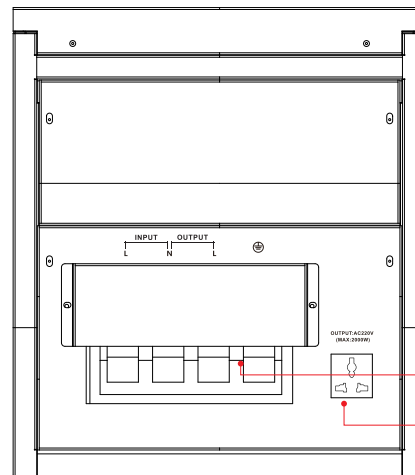

Terminal block

Universal socket

Widely used in various industries, small office equipment, refrigerator, electric fan, computer, pump, air conditioner, etc.



Washing Maching

LCD TV

Rice Cooker

Microwave Oven

Printer

Computer

Relay Control + Toroidal Transformer, Efficiency > 97%

# ARS-ZMA95

Series

(3KVA - 20KVA)



ISO9001



The product of this model is a **220V** fully automatic voltage regulator, both for desktop & wall mounted. With LED Digital Display design. It is characterized by stable work, high pressure regulation speed and wide voltage regulation range.

## TECHNICAL DATA

MODEL	ARS-ZMA95-3000VA	ARS-ZMA95-5000VA
INPUT VOLTAGE	AC 95V-270V	
OUTPUT VOLTAGE	AC 220V±10% 50/60Hz	
DELAY TIME	Short Delay:3-5sec Long delay:3-7min	
PROTECTION	Over Voltage(246V±4V),Overload,High Temperature,Short Circuit	
POWER	3000VA	5000VA
PRODUCT SIZE(CM)	33.3x18.7x15.8	33.3x18.7x15.8
PACKING SIZE(CM)	38x27.5x22.3	38x27.5x22.3
PCS/CARTON	1	1
N.W.(KG)	8.2	9.8
G.W.(KG)	8.5	10.2

LED Display



Switch Button



## TECHNICAL DATA

MODEL	ARS-ZMA95-10KVA	ARS-ZMA95-15KVA	ARS-ZMA95-20KVA
INPUT VOLTAGE	AC 95V-270V		
OUTPUT VOLTAGE	AC 220V±10% 50/60Hz		
DELAY TIME	Short Delay:3-5sec Long delay:3-7min		
PROTECTION	Over Voltage(246V±4V),Overload,High Temperature,Short Circuit		
POWER	10000VA	15000VA	20000VA
PRODUCT SIZE(CM)	44.8x24.7x18.8	46.8x26.7x19.8	46.8x26.7x20.8
PACKING SIZE(CM)	50x30x22	52x32x23	52x32x24
PCS/CARTON	1	1	1
N.W.(KG)	19	22.8	24.6
G.W.(KG)	19.5	23.8	26

Widely used in various industries, small office equipment, refrigerator, electric fan, computer, pump, air conditioner, etc.



Washing Maching Fridge Air Conditioner Air compressor Motor Water pump

Relay Control + Toroidal Transformer, Efficiency > 97%

# ARS-ZMA95

Series

(25KVA)



ISO9001



The product of this model is a **220V** fully automatic voltage regulator, both for desktop & wall mounted. With LED Digital Display design. It is characterized by stable work, high pressure regulation speed and wide voltage regulation range.

## TECHNICAL DATA

MODEL	ZMA95-25KVA
INPUT VOLTAGE	AC 95V-270V
OUTPUT VOLTAGE	AC 220V±10% 50/60Hz
DELAY TIME	Short Delay:3-5sec Long Delay:3-7min
PROTECTION	Over Voltage(246V±4V),Overload,High Temperature,Short Circuit
POWER	25KVA
PRODUCT SIZE(CM)	43.3x34.2x28.8
PACKING SIZE(CM)	48x39x34
PCS/CARTON	1
N.W.(KG)	36.7
G.W.(KG)	41.7

LED Display



Switch Button

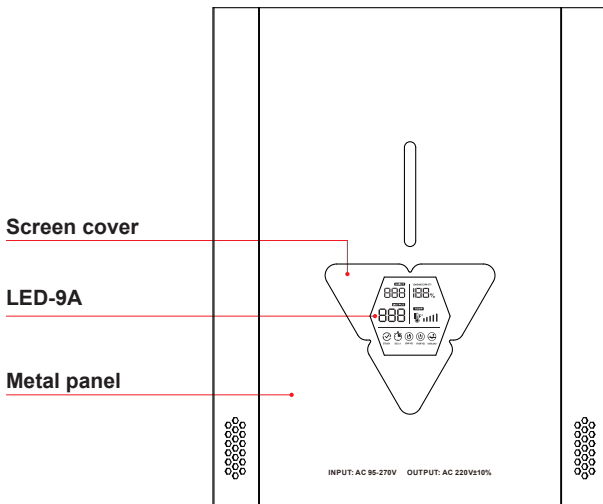

## TECHNICAL DRAWING

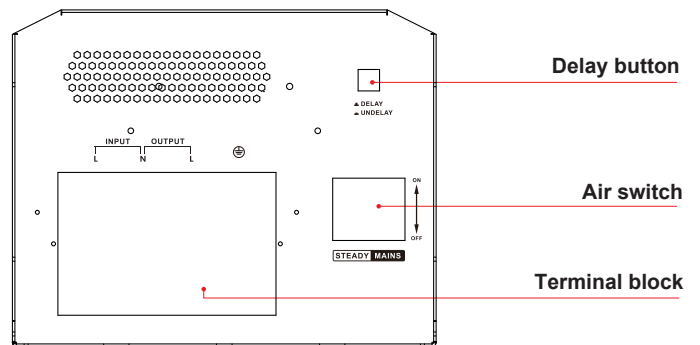

Widely used in various industries, small office equipment, refrigerator, electric fan, computer, pump, air conditioner, etc.



Washing Maching    LCD TV    Rice Cooker    Microwave Oven    Printer    Computer

Relay Control + Toroidal Transformer, Efficiency > 97%

# ARS-ZMA-K

Series (1P-1.5P)



ISO9001



The product of this model is a **220V** fully automatic voltage regulator, design of LCD Digital Display and easy move. It is characterized by stable work, high pressure regulation speed and wide voltage regulation range.

## TECHNICAL DATA

MODEL	ARS-ZMA-K1P	ARS-ZMA-K1.5P
INPUT VOLTAGE	AC 95V-270V	
OUTPUT VOLTAGE	AC 220V±10% 50/60Hz	
DELAY TIME	Short Delay:3-5sec Long Deley:3-7min	
PROTECTION	Over Voltage(246V±4V),Overload,High Temperature,Short Circuit	
POWER	1P	1.5P
PRODUCT SIZE(CM)	27.5x18.7x14.3	27.5x18.7x14.3
PACKING SIZE(CM)	32.5x27.5x22.3	32.5x27.5x22.3
PCS/CARTON	1	1
N.W.(KG)	6.5	7.6
G.W.(KG)	6.9	8

LED Display



Switch Button



## TECHNICAL DRAWING

Screen cover

LED-9A

Metal panel

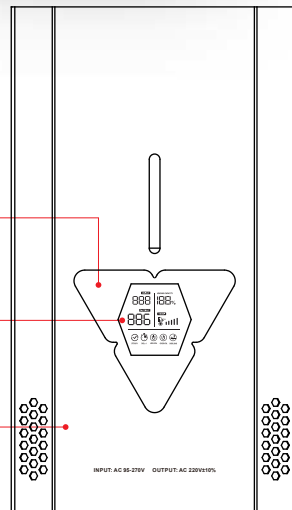

Delay button

Air switch

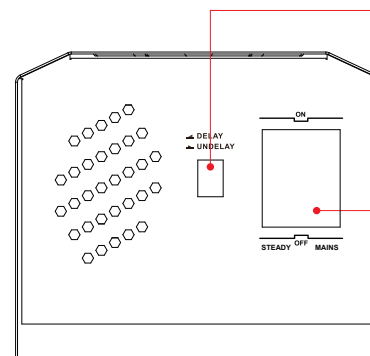

Widely used in various industries, small office equipment, refrigerator, electric fan, computer, pump, air conditioner, etc.



Washing Maching Fridge Air Conditioner Air compressor Motor Water pump

Relay Control + Toroidal Transformer, Efficiency > 97%

# ARS-ZMB95

Series

(3KVA - 20KVA)



ISO9001



The product of this model is a **220V** fully automatic voltage regulator, both for desktop & wall mounted. With LED Digital Display design. It is characterized by stable work, high pressure regulation speed and wide voltage regulation range.

## TECHNICAL DATA

MODEL	ARS-ZMB95-3000VA	ARS-ZMB95-5000VA
INPUT VOLTAGE	AC 95V-270V	
OUTPUT VOLTAGE	AC 220V±10% 50/60Hz	
DELAY TIME	Short Delay:3-5sec Long delay:3-7min	
PROTECTION	Over Voltage(246V±4V),Overload,High Temperature,Short Circuit	
POWER	3000VA	5000VA
PRODUCT SIZE(CM)	33.3x18.7x15.8	33.3x18.7x15.8
PACKING SIZE(CM)	38x27.5x22.3	38x27.5x22.3
PCS/CARTON	1	1
N.W.(KG)	8.2	9.8
G.W.(KG)	8.5	10.2

LED Display



Switch Button



## TECHNICAL DATA

MODEL	ARS-ZMB95-10KVA	ARS-ZMB95-15KVA	ARS-ZMB95-20KVA
INPUT VOLTAGE	AC 95V-270V		
OUTPUT VOLTAGE	AC 220V±10% 50/60Hz		
DELAY TIME	Short Delay:3-5sec Long delay:3-7min		
PROTECTION	Over Voltage(246V±4V),Overload,High Temperature,Short Circuit		
POWER	10000VA	15000VA	20000VA
PRODUCT SIZE(CM)	44.8x24.7x18.8	46.8x26.7x19.8	46.8x26.7x20.8
PACKING SIZE(CM)	50x30x22	52x32x23	52x32x24
PCS/CARTON	1	1	1
N.W.(KG)	19	22.8	24.6
G.W.(KG)	19.5	23.8	26

Widely used in various industries, small office equipment, refrigerator, electric fan, computer, pump, air conditioner, etc.



Washing Maching    LCD TV    Rice Cooker    Microwave Oven    Printer    Computer

Relay Control + Toroidal Transformer, Efficiency > 97%

# ARS-ZMB95

Series (25KVA)



ISO9001



The product of this model is a **220V** fully automatic voltage regulator, both for desktop & wall mounted. With LED Digital Display design. It is characterized by stable work, high pressure regulation speed and wide voltage regulation range.

## TECHNICAL DATA

MODEL	AR-ZMB95-25KVA
INPUT VOLTAGE	AC 95V-270V
OUTPUT VOLTAGE	AC 220V±10% 50/60Hz
DELAY TIME	Short Delay:3-5sec Long Delay:3-7min
PROTECTION	Over Voltage(246V±4V),Overload,High Temperature,Short Circuit
POWER	25KVA
PRODUCT SIZE(CM)	43.3x34.2x28.8
PACKING SIZE(CM)	48x39x34
PCS/CARTON	1
N.W.(KG)	36.7
G.W.(KG)	41.7

LED Display



Switch Button



Screen cover

LED-9A

Metal panel

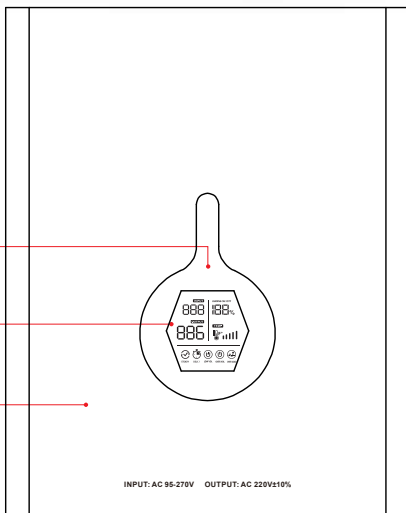

## TECHNICAL DRAWING

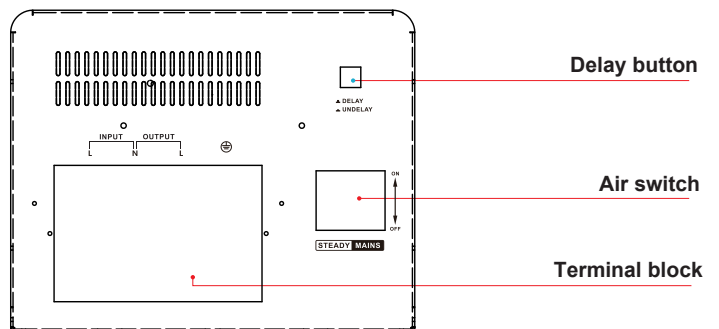

Widely used in various industries, small office equipment, refrigerator, electric fan, computer, pump, air conditioner, etc.



Relay Control + Toroidal Transformer, Efficiency > 97%



**ARAKAWA STABILIZER**  
Digital Display



# RELAY TYPE

Arakawa Relay Type Stabilizers deliver cost-effective voltage control using electro-magnetic relays, ensuring a dependable solution for maintaining stable power in your electrical systems.

ISO9001	NORMAL	DELAY	LOW VOL	OVER VOL	OVER LOAD
---------	--------	-------	---------	----------	-----------

# ARS-TAC95

Series

(500VA-1000VA)

ISO9001



The product of this model is a 220V fully automatic voltage regulator, both for desktop and wall mounted. With LED digital display design. It is characterized by stable work, high pressure regulation speed and wide voltage regulation range.



## TECHNICAL DATA

MODEL	ARS-TAC95(500VA-1000VA)	
INPUT VOLTAGE	AC 95V-270V	
OUTPUT VOITAGE	AC 220V±10% 50/60Hz	
DELAY TIME	Short Delay:3-5sec Long Deley:3-7min	
PROTECTION	Over Voltage(246V±4V),Overload,High Temperature,Short Circuit	
POWER	500VA	1000VA
PRODUCT SIZE(CM)	29.8x11.7x7.2	29.8x11.7x7.2
PACKING SIZE(CM)	46x39x19.5	46x39x19.5
PCS/CARTON	6	6
N.W.(KG)	24	26
G.W.(KG)	27	29

LED Display



Switch Button



LED-5C

Plastic panel

Switch

Fuse socket

Socket

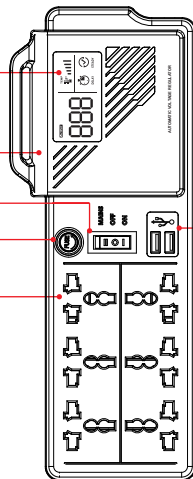

USB

## TECHNICAL DRAWING

RJ45 input

RJ45 output

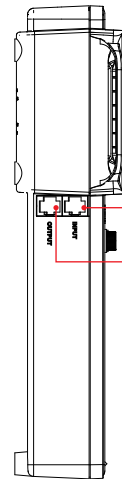

Widely used in various industries, small office equipment, refrigerator, electric fan, computer, pump, air conditioner, etc.



Washing Maching Fridge Air Conditioner Air compressor Motor Water pump

Relay Control + Toroidal Transformer, Efficiency > 97%

# ARS-TAB95

Series

(500VA-1000VA)

ISO9001



The product of this model is a 220V fully automatic small-sized voltage regulator, which is a portable LED digital display design. It is characterized by small size, light weight, high voltage regulation speed and no waveform distortion.



## TECHNICAL DATA

MODEL	ARS-TAB95(500VA-1000VA)	
INPUT VOLTAGE	AC 95V-270V	
OUTPUT VOITAGE	AC 220V±10% 50/60Hz	
DELAY TIME	Short Delay:3-5sec Long Deley:3-7min	
PROTECTION	Over Voltage(246V±4V),Overload,High Temperature,Short Circuit	
POWER	500VA	1000VA
PRODUCT SIZE(CM)	36x12.2x8.4	36x12.2x8.4
PACKING SIZE(CM)	52x41x27.5	52x41x27.5
PCS/CARTON	6	6
N.W.(KG)	13.2	14.4
G.W.(KG)	16	17.2

LED Display



Switch Button

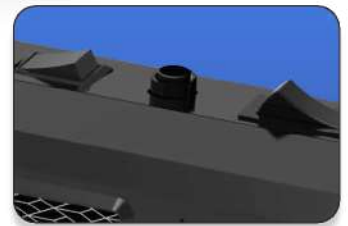

Plastic panel

Socket

LED-5A

USB

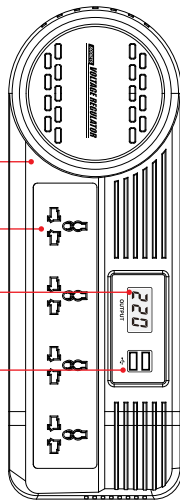

## TECHNICAL DRAWING

Delay button

Fuse socket

Switch

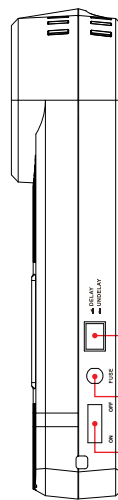

Widely used in various industries, small office equipment, refrigerator, electric fan, computer, pump, air conditioner, etc.



Washing Maching LCD TV Rice Cooker Microwave Oven Printer Computer

Relay Control + Toroidal Transformer, Efficiency > 97%

HOT!!!

# ARS-TMU<sub>45/60/95</sub>

Series (3000VA-5000VA)



ISO9001



The product of this model is a **220V** fully automatic voltage regulator, both for desktop & wall mounted. With LED digital display design. It is characterized by stable work, high pressure regulation speed and wide voltage regulation range.

### TECHNICAL DATA

MODEL	ARS-TMU45-3000VA	ARS-TMU60-3000VA	ARS-TMU95-3000VA
INPUT VOLTAGE	AC 45V-270V	AC 60V-270V	AC 95V-270V
OUTPUT VOLTAGE	AC 220V±10% 50/60Hz		
DELAY TIME	Short Delay:3-5sec Long delay:3-7min		
PROTECTION	Over Voltage(246V±4V),Overload,High Temperature,Short Circuit		
POWER	3000VA		
PRODUCT SIZE(CM)	35.3x19.2x15.3		
PACKING SIZE(CM)	40.5x24.5x21		
PCS/CARTON	1		
N.W.(KG)	8.4		
G.W.(KG)	8.7		

LED Display



Air Circulation



### TECHNICAL DATA

MODEL	ARS-TMU45-5000VA	ARS-TMU60-5000VA	ARS-TMU95-5000VA
INPUT VOLTAGE	AC 45V-280V	AC 60V-280V	AC 95V-280V
OUTPUT VOLTAGE	AC 220V±10% 50/60Hz		
DELAY TIME	Short Delay:3-5sec Long Delay:3-7min		
PROTECTION	Over Voltage(246V±4V),Overload,High Temperature,Short Circuit		
POWER	5000VA		
PRODUCT SIZE(CM)	42x29x13.8		
PACKING SIZE(CM)	47x34x19.5		
PCS/CARTON	1		
N.W.(KG)	15.3		
G.W.(KG)	16.6		

● ● ●  
Widely used in various industries, small office equipment, refrigerator, electric fan, computer, pump, air conditioner, etc.



Washing Maching    Fridge    Air Conditioner    Air compressor    Motor    Water pump

Relay Control + Toroidal Transformer, Efficiency > 97%

**ARS-TMU** <sup>HOT!!!</sup> **45/60/95**  
Series (8000VA-12KVA)



ISO9001



The product of this model is a **220V** fully automatic voltage regulator, both for desktop & wall mounted. With LED digital display design. It is characterized by stable work, high pressure regulation speed and wide voltage regulation range.

TECHNICAL DATA

MODEL	ARS-TMU45 (8000VA-12KVA)	ARS-TMU60 (8000VA-12KVA)	ARS-TMU95 (8000VA-12KVA)
INPUT VOLTAGE	AC 45V-280V	AC 60V-280V	AC 95V-280V
OUTPUT VOLTAGE	AC 220V±10% 50/60Hz		
DELAY TIME	Short Delay:3-5sec Long Delay:3-7min		
PROTECTION	Over Voltage(246V±4V),Overload,High Temperature,Short Circuit		
POWER	8000VA	10000VA	12000VA
PRODUCT SIZE(CM)	46x32x16.9	46x32x16.9	46x32x16.9
PACKING SIZE(CM)	51.5x37.5x23	51.5x37.5x23	51.5x37.5x23
PCS/CARTON	1	1	1
N.W.(KG)	18.4	22.8	23.6
G.W.(KG)	19.2	23.8	24.6

LED Display



Air Circulation



Screen cover

LED-3E

Metal panel

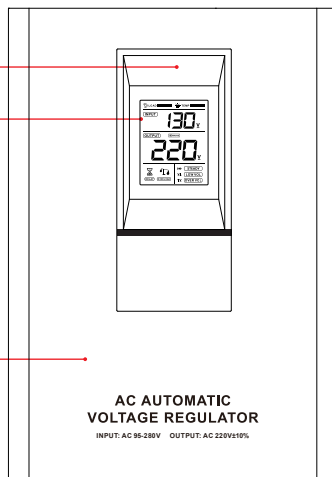

TECHNICAL DRAWING

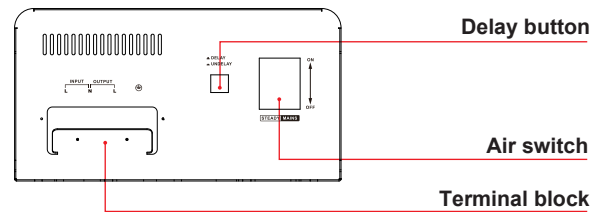

• • •  
Widely used in various industries, small office equipment, refrigerator, electric fan, computer, pump, air conditioner, etc.



Washing Maching LCD TV Rice Cooker Microwave Oven Printer Computer

Relay Control + Toroidal Transformer, Efficiency > 97%

HOT!!!

# ARS-TMU<sub>45/60/95</sub> Series (15KVA-20KVA)



ISO9001



The product of this model is a **220V** fully automatic voltage regulator, both for desktop & wall mounted. With LED digital display design. It is characterized by stable work, high pressure regulation speed and wide voltage regulation range.

### TECHNICAL DATA

MODEL	ARS-TMU45 (15KVA/20KVA)	ARS-TMU60 (15KVA/20KVA)	ARS-TMU95 (15KVA/20KVA)
INPUT VOLTAGE	AC 45V-280V	AC 60V-280V	AC 95V-280V
OUTPUT VOLTAGE	AC 220V±10% 50/60Hz		
DELAY TIME	Short Delay:3-5sec Long Delay:3-7min		
PROTECTION	Over Voltage(246V±4V),Overload,High Temperature,Short Circuit		
POWER	15000VA	20000VA	
PRODUCT SIZE(CM)	30.2×29×41	30.2×29×41	
PACKING SIZE(CM)	37.5×36.5×50	37.5×36.5×50	
PCS/CARTON	1	1	
N.W.(KG)	28.7	30.6	
G.W.(KG)	32.2	34.1	

LED Display



Switch Button



Metal panel

LED-3G

Screen cover

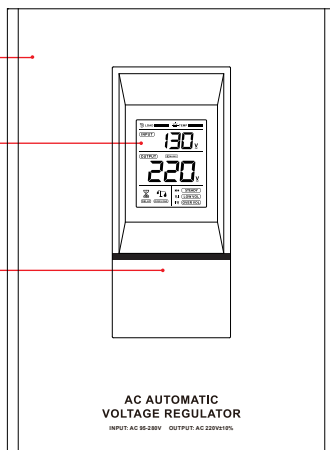

### TECHNICAL DRAWING

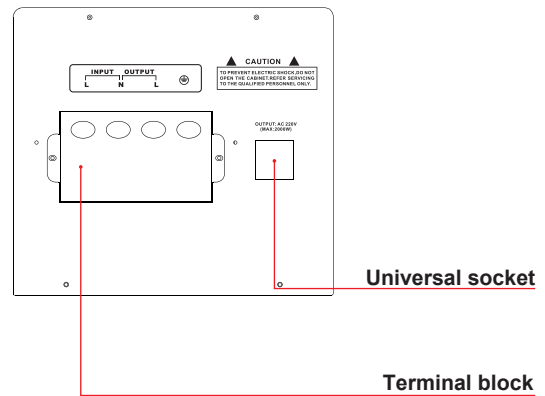

Widely used in various industries, small office equipment, refrigerator, electric fan, computer, pump, air conditioner, etc.



Relay Control + Toroidal Transformer, Efficiency > 97%

**ARS-TMU** <sup>HOT!!!</sup> **45/60/95**  
Series (30KVA)



ISO9001



The product of this model is a **220V** fully automatic voltage regulator, both for desktop & wall mounted. With LED digital display design. It is characterized by stable work, high pressure regulation speed and wide voltage regulation range.

TECHNICAL DATA

MODEL	ARS-TMU45-30KVA	ARS-TMU60-30KVA	ARS-TMU95-30KVA
INPUT VOLTAGE	AC 45V-280V	AC 60V-280V	AC 95V-280V
OUTPUT VOLTAGE	AC 220V±10% 50/60Hz		
DELAY TIME	Short Delay:3-5sec Long delay:3-7min		
PROTECTION	Over Voltage(246V±4V),Overload,High Temperature,Short Circuit		
POWER	30000VA		
PRODUCT SIZE(CM)	41.5x45x52.2		
PACKING SIZE(CM)	50.5x47x67		
PCS/CARTON	1		
N.W.(KG)	49		
G.W.(KG)	54		

LED Display



Switch Button



TECHNICAL DRAWING

Metal panel

LED-3E

Screen cover

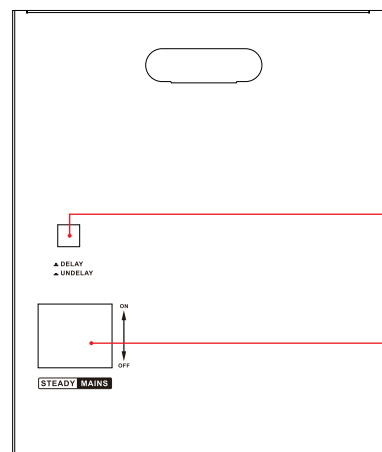
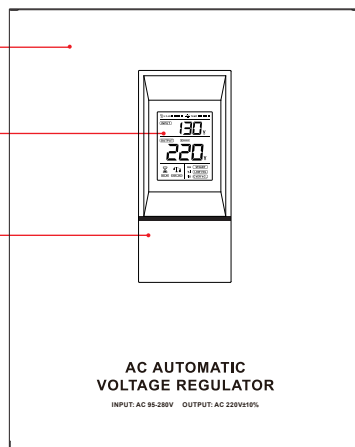

Widely used in various industries, small office equipment, refrigerator, electric fan, computer, pump, air conditioner, etc.



Washing Maching LCD TV Rice Cooker Microwave Oven Printer Computer

Relay Control + Toroidal Transformer, Efficiency > 97%

# ARS-TMB<sup>HOT!!!</sup>45/60/95

Series (500VA-2000VA)



**FEATURES**

- PRECISE ZERO CROSSING TECHNOLOGY
- FAST CREATION AND HIGH EFFICIENCY
- FULL PROTECTION: OVER VOLTAGE, OVERLOAD, OVER HEAT, SHORT CIRCUIT
- WIDE INPUT VOLTAGE RANGE
- WIDE RANGE APPLIANCE, SUITABLE FOR ALL HOME AND OFFICE APPLIANCE

ISO9001



The product of this model is a **220V** fully automatic small-sized voltage regulator, both for desktop and wall mounted. With LED digital display design. It is characterized by small size, light weight, easy to use and install, reliable operation and high pressure regulation speed.

## TECHNICAL DATA

MODEL	ARS-TMB(500VA-2000VA)	ARS-TMB95(500VA-2000VA)
INPUT VOLTAGE	AC 130V-270V	AC 95V-280V
OUTPUT VOITAGE	AC 220V±10% 50/60Hz	
DELAY TIME	Short Delay:3-5sec Long delay:3-7min	
PROTECTION	Over Voltage(246V±4V), Overload, High Temperature, Short Circuit	
POWER	500VA 1000VA	1500VA 2000VA
PRODUCT SIZE(CM)	17.5x16.5x12	17.5x16.5x12 24x16.5x12
PACKING SIZE(CM)	52.5x27x39	52.5x27x39 53x33.6x39
PCS/CARTON	4	4 4
N.W.(KG)	12.8	15 18.8
G.W.(KG)	14.6	16.4 20.6 26.5

MODEL	ARS-TMB45(1000VA-2000VA)	ARS-TMB60(1000VA-2000VA)
INPUT VOLTAGE	AC 45V-270V	AC 60V-280V
OUTPUT VOITAGE	AC 220V±10% 50/60Hz	
DELAY TIME	Short Delay:3-5sec Long delay:3-7min	
PROTECTION	Over Voltage(246V±4V), Overload, High Temperature, Short Circuit	
POWER	1000VA	1500VA 2000VA
PRODUCT SIZE(CM)	24x16.5x12	24x16.5x12 26.2x16.5x12
PACKING SIZE(CM)	53x33.6x39	53x33.6x39 53x35.6x39
PCS/CARTON	4	4 4
N.W.(KG)	16.4	19.8 25.2
G.W.(KG)	17.8	20.6 28

Metal panel

LED-1B

Screen cover

Delay button

Switch

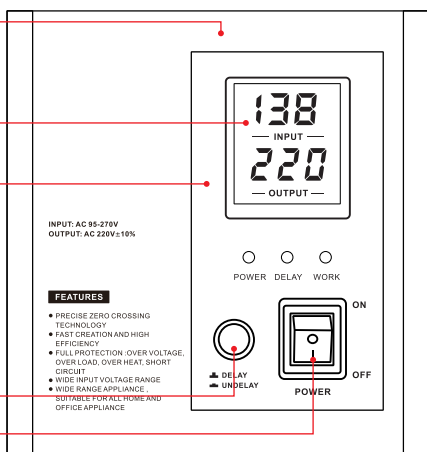

## TECHNICAL DRAWING

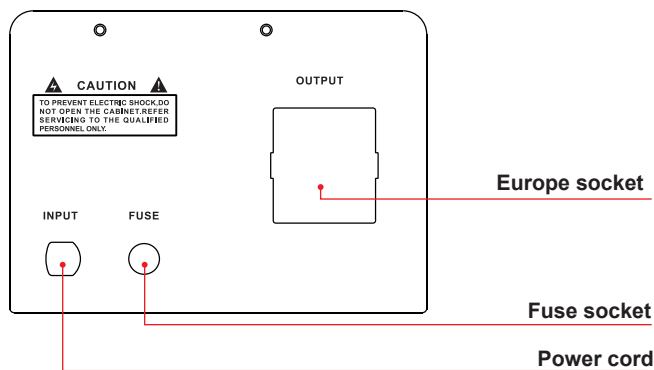

Widely used in various industries, small office equipment, refrigerator, electric fan, computer, pump, air conditioner, etc.



Washing Maching Fridge Air Conditioner Air compressor Motor Water pump

Relay Control + Toroidal Transformer, Efficiency > 97%



HOT!!!

# ARS-TMB<sub>45/60/95</sub>

Series (3000VA-5000VA)



ISO9001



The product of this model is a **220V** fully automatic voltage regulator, both for desktop & wall mounted. With LED digital display design. It is characterized by stable work, high pressure regulation speed and wide voltage regulation range.

### TECHNICAL DATA

MODEL	ARS-TMB 3000VA	ARS-TMB45 3000VA	ARS-TMB60 3000VA	ARS-TMB95 3000VA
INPUT VOLTAGE	AC 130V-270V	AC 45V-270V	AC 60V-270V	AC 95V-270V
OUTPUT VOITAGE	AC 220V±10% 50/60Hz			
DELAY TIME	Short Delay:3-5sec Long Deley:3-7min			
PROTECTION	Over Voltage(246V±4V),Overload,High Temperature,Short Circuit			
POWER	3000VA			
PRODUCT SIZE(CM)	33x24x14			
PACKING SIZE(CM)	38.5x33.5x21.2			
PCS/CARTON	1			
N.W.(KG)	11.2			
G.W.(KG)	11.8			

LED Display



Switch Button



### TECHNICAL DATA

MODEL	ARS-TMB 5000VA	ARS-TMB45 5000VA	ARS-TMB60 5000VA	ARS-TMB95 5000VA
INPUT VOLTAGE	AC 130V-270V	AC 45V-280V	AC 60V-280V	AC 95V-280V
OUTPUT VOITAGE	AC 220V±10% 50/60Hz			
DELAY TIME	Short Delay:3-5sec Long Deley:3-7min			
PROTECTION	Over Voltage(246V±4V),Overload,High Temperature,Short Circuit			
POWER	5000VA			
PRODUCT SIZE(CM)	36.5x27x17.5			
PACKING SIZE(CM)	41.5x36.5x24.5			
PCS/CARTON	1			
N.W.(KG)	15.4			
G.W.(KG)	16.2			

Widely used in various industries, small office equipment, refrigerator, electric fan, computer, pump, air conditioner, etc.



Washing Maching LCD TV Rice Cooker Microwave Oven Printer Computer

Relay Control + Toroidal Transformer, Efficiency > 97%

# ARS-TMB<sub>45/60/95</sub>

Series (8000VA-12KVA)

HOT!!!



**FEATURES**

- PRECISE ZERO CROSSING TECHNOLOGY
- FAST CREATION AND HIGH EFFICIENCY
- FULL PROTECTION OVER VOLTAGE, OVER LOAD, OVER HEAT, SHORT CIRCUIT
- INTELLIGENT AUTO COOLING FAN
- WIDE INPUT VOLTAGE RANGE
- WIDE RANGE APPLIANCE, SUITABLE FOR ALL HOME AND OFFICE APPLIANCE, ESPECIALLY FOR AIR CONDITIONER

ISO9001



The product of this model is a **220V** fully automatic voltage regulator, both for desktop & wall mounted. With LED digital display design. It is characterized by stable work, high pressure regulation speed and wide voltage regulation range.

**TECHNICAL DATA**

MODEL	ARS-TMB (8000VA-12KVA)	ARS-TMB45 (8000VA-12KVA)	ARS-TMB60 (8000VA-12KVA)	ARS-TMB95 (8000VA-12KVA)
INPUT VOLTAGE	AC 130V-270V	AC 45V-280V	AC 60V-280V	AC 95V-280V
OUTPUT VOITAGE	AC 220V±10% 50/60Hz			
DELAY TIME	Short Delay:3-5sec Long Deley:3-7min			
PROTECTION	Over Voltage(246V±4V),Overload,High Temperature,Short Circuit			
POWER	8000VA	10000VA	12000VA	
PRODUCT SIZE(CM)	39.5x30x19	39.5x30x19	39.5x30x19	
PACKING SIZE(CM)	45x39.5x25.7	45x39.5x25.7	45x39.5x25.7	
PCS/CARTON	1	1	1	
N.W.(KG)	20	22.6	23.3	
G.W.(KG)	21.1	23.5	24.3	

LED Display



Switch Button



Screen cover

LED-1B

Indicator light board

Delay button

Air switch

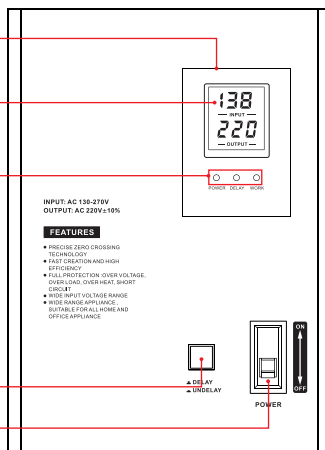

**TECHNICAL DRAWING**

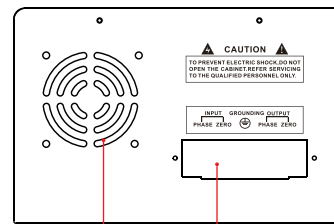

Terminal block

Fan

Widely used in various industries, small office equipment, refrigerator, electric fan, computer, pump, air conditioner, etc.



Washing Maching Fridge Air Conditioner Air compressor Motor Water pump

Relay Control + Toroidal Transformer, Efficiency > 97%

# ARS-TMB<sup>HOT!!!</sup>45/60/95

Series (15KVA-20KVA)



The product of this model is a **220V** fully automatic voltage regulator, both for desktop & wall mounted. With LED digital display design. It is characterized by stable work, high pressure regulation speed and wide voltage regulation range.

### TECHNICAL DATA

MODEL	ARS-TMB (15KVA/20KVA)	ARS-TMB45 (15KVA/20KVA)	ARS-TMB60 (15KVA/20KVA)	ARS-TMB95 (15KVA/20KVA)
INPUT VOLTAGE	AC 130V-270V	AC 45V-280V	AC 60V-280V	AC 95V-280V
OUTPUT VOITAGE	AC 220V±10% 50/60Hz			
DELAY TIME	Short Delay:3-5sec Long Deley:3-7min			
PROTECTION	Over Voltage(246V±4V),Overload,High Temperature,Short Circuit			
POWER	15000VA		20000VA	
PRODUCT SIZE(CM)	30x27x42.5		30x27x42.5	
PACKING SIZE(CM)	36x32.5x51.5		36x32.5x51.5	
PCS/CARTON	1		1	
N.W.(KG)	29.3		31.6	
G.W.(KG)	33.1		35.4	

LED Display



Switch Button



### AC AUTOMATIC VOLTAGE REGULATOR

**FEATURES**

- INTELLIGENT AUTO COOLING FAN
- WIDE INPUT VOLTAGE RANGE
- WIDE RANGE APPLIANCE, SUITABLE FOR ALL HOME AND OFFICE APPLIANCE, ESPECIALLY FOR AIR CONDITIONER
- PRECISE ZERO CROSSING TECHNOLOGY
- FAST CREATION AND HIGH EFFICIENCY
- FULL PROTECTION: OVER VOLTAGE, OVER LOAD, OVER HEAT, SHORT CIRCUIT

### TECHNICAL DRAWING

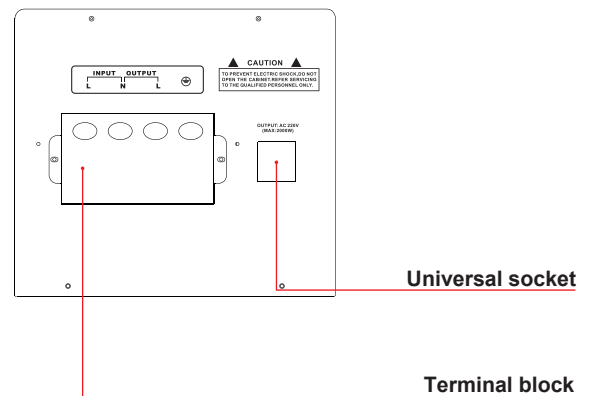
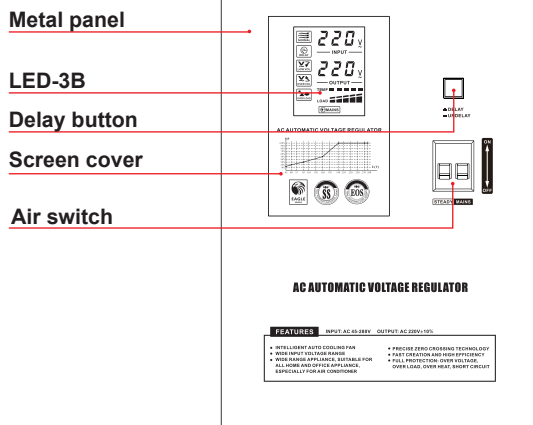

Widely used in various industries, small office equipment, refrigerator, electric fan, computer, pump, air conditioner, etc.



Relay Control + Toroidal Transformer, Efficiency > 97%

**ARS-TM45/60/95**  
Series (5000VA-15KVA)

HOT!!!



ISO9001



The product of this model is a 220V fully automatic voltage regulator, with Wall-mounted design, the appearance is concise and generous. Display of LED digital design. it is characterized by stable work, high pressure regulation voltage regulation range. speed and wide voltage regulation range.

TECHNICAL DATA

MODEL	ARS-TM (5000VA-15KVA)	ARS-TM45 (5000VA-15KVA)	ARS-TM60 (5000VA-15KVA)	ARS-TM95 (5000VA-15KVA)	
INPUT VOLTAGE	AC 130V-270V	AC 45V-280V	AC 60V-280V	AC 95V-280V	
OUTPUT VOITAGE	AC 220V±10% 50/60Hz				
DELAY TIME	Short Delay:3-5sec				
PROTECTION	Over Voltage(246V±4V),Overload,High Temperature,Short Circuit				
POWER	5000VA	8000VA	10000VA	12000VA	15000VA
PRODUCT SIZE(CM)	44x32x21	44x32x21	44x32x21	44x32x21	44x32x21
PACKING SIZE(CM)	51x38.5x26	51x38.5x26	51x38.5x26	51x38.5x26	51x38.5x26
PCS/CARTON	1	1	1	1	1
N.W.(KG)	16.5	18.7	22.4	23.2	24.9
G.W.(KG)	17.8	20	23.7	24.5	26.2

LED Display



Indicator light



TECHNICAL DRAWING

Screen sticker

Metal panel

Indicator light board

LED-1B

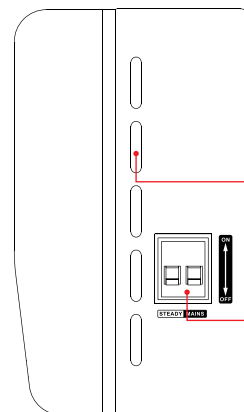
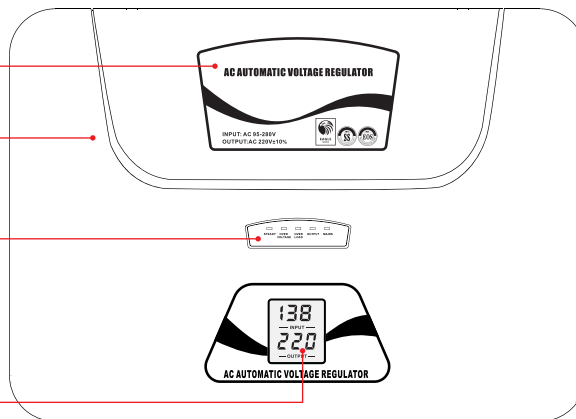

Widely used in various industries, small office equipment, refrigerator, electric fan, computer, pump, air conditioner, etc.



Washing Maching Fridge Air Conditioner Air compressor Motor Water pump

Relay Control + Toroidal Transformer, Efficiency > 97%

HOT!!!

# ARS-MOD 45/60/95 Series (3000VA-8000VA)



ISO9001



The product of this model is a **220V** fully automatic voltage regulator, both for desktop & wall mounted. With LED digital display design. It is characterized by stable work, high pressure regulation speed and wide voltage regulation range.

### TECHNICAL DATA

MODEL	ARS-MOD45 3000VA	ARS-MOD60 3000VA	ARS-MOD95 3000VA
INPUT VOLTAGE	AC 45V-270V	AC 60V-270V	AC 95V-270V
OUTPUT VOLTAGE	AC 220V±10% 50/60Hz		
DELAY TIME	Short Delay:3-5sec Long delay:3-7min		
PROTECTION	Over Voltage(246V±4V),Overload,High Temperature,Short Circuit		
POWER	3000VA		
PRODUCT SIZE(CM)	39x24.5x10		
PACKING SIZE(CM)	44x29.5x15.3		
PCS/CARTON	1		
N.W.(KG)	10.9		
G.W.(KG)	11.3		

LED Display



Switch Button



### TECHNICAL DATA

MODEL	ARS-MOD45 (5000VA-8000VA)	ARS-MOD60 (5000VA-8000VA)	ARS-MOD95 (5000VA-8000VA)
INPUT VOLTAGE	AC 45V-280V	AC 60V-280V	AC 95V-280V
OUTPUT VOLTAGE	AC 220V±10% 50/60Hz		
DELAY TIME	Short Delay:3-5sec Long delay:3-7min		
PROTECTION	Over Voltage(246V±4V),Overload,High Temperature,Short Circuit		
POWER	5000VA	8000VA	
PRODUCT SIZE(CM)	41x29.5x15	41x29.5x15	
PACKING SIZE(CM)	46x34.5x21	46x34.5x21	
PCS/CARTON	1	1	
N.W.(KG)	16.6	17.9	
G.W.(KG)	17.4	18.7	

Widely used in various industries, small office equipment, refrigerator, electric fan, computer, pump, air conditioner, etc.



Washing Maching Fridge Air Conditioner Air compressor Motor Water pump

Relay Control + Toroidal Transformer, Efficiency > 97%

HOT!!!

# ARS-MOD 45/60/95 Series (10KVA-15KVA)



ISO9001



The product of this model is a **220V** fully automatic voltage regulator, both for desktop & wall mounted. With LED digital display design. It is characterized by stable work, high pressure regulation speed and wide voltage regulation range.

## TECHNICAL DATA

MODEL	ARS-MOD45 (10KVA-15KVA)	ARS-MOD60 (10KVA-15KVA)	ARS-MOD95 (10KVA-15KVA)
INPUT VOLTAGE	AC 45V-280V	AC 60V-280V	AC 95V-280V
OUTPUT VOLTAGE	AC 220V±10% 50/60Hz		
DELAY TIME	Short Delay:3-5sec Long Delay:3-7min		
PROTECTION	Over Voltage(246V±4V),Overload,High Temperature,Short Circuit		
POWER	10KVA	12KVA	15KVA
PRODUCT SIZE(CM)	45x31.5x17	45x31.5x17	45x31.5x17
PACKING SIZE(CM)	51.8x38.5x23.7	51.8x38.5x23.7	51.8x38.5x23.7
PCS/CARTON	1	1	1
N.W.(KG)	22.9	25.2	26.3
G.W.(KG)	23.8	26.1	27.2

LED Display



Switch Button



Screen cover

LED-3L

Metal panel

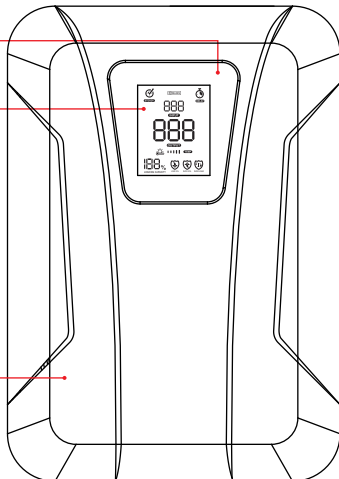

## TECHNICAL DRAWING

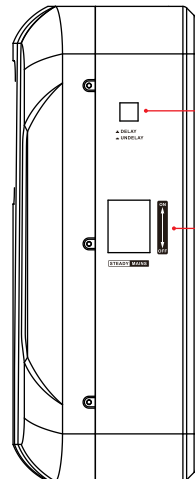

Delay button

Air switch

Widely used in various industries, small office equipment, refrigerator, electric fan, computer, pump, air conditioner, etc.



Washing Maching Fridge Air Conditioner Air compressor Motor Water pump

Relay Control + Toroidal Transformer, Efficiency > 97%

HOT!!!

# ARS-MOD 45/60/95

Series (20KVA)



ISO9001



The product of this model is a **220V** fully automatic voltage regulator, both for desktop & wall mounted. With LED digital display design. It is characterized by stable work, high pressure regulation speed and wide voltage regulation range.

## TECHNICAL DATA

MODEL	ARS-MOD45 20KVA	ARS-MOD60 20KVA	ARS-MOD95 20KVA
INPUT VOLTAGE	AC 45V-280V	AC 60V-280V	AC 95V-280V
OUTPUT VOLTAGE	AC 220V±10% 50/60Hz		
DELAY TIME	Short Delay:3-5sec Long delay:3-7min		
PROTECTION	Over Voltage(246V±4V),Overload,High Temperature,Short Circuit		
POWER	20KVA		
PRODUCT SIZE(CM)	45x31.5x18		
PACKING SIZE(CM)	51.8x38.5x24.7		
PCS/CARTON	1		
N.W.(KG)	29		
G.W.(KG)	29.8		

LED Display



Switch Button



Screen cover

LED-3L

Metal panel

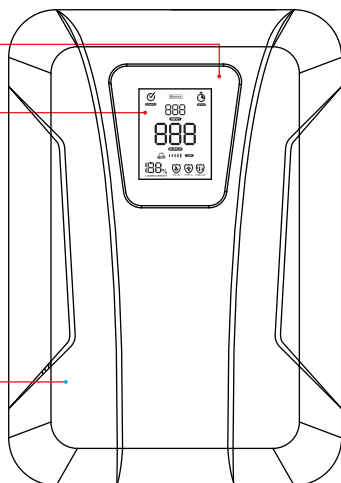

## TECHNICAL DRAWING

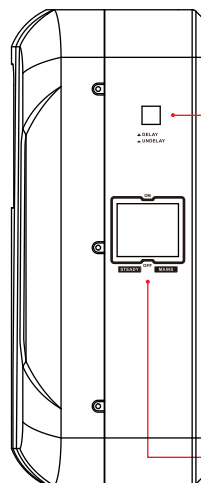

Delay button

Air switch

• • •

Widely used in various industries, small office equipment, refrigerator, electric fan, computer, pump, air conditioner, etc.



Washing Maching    LCD TV    Rice Cooker    Microwave Oven    Printer    Computer

Relay Control + Toroidal Transformer, Efficiency > 97%

# ARS-TMP<sub>45/60/95</sub>

Series (3000VA-8000VA)



ISO9001



The product of this model is a **220V** fully automatic voltage regulator, both for desktop & wall mounted. With LED digital display design. It is characterized by stable work, high pressure regulation speed and wide voltage regulation range.

## TECHNICAL DATA

MODEL	ARS-TMP95(3000VA-5000VA)	
INPUT VOLTAGE	AC 95V-270V	
OUTPUT VOLTAGE	AC 220V±10% 50/60Hz	
DELAY TIME	Short Delay:3-5sec Long delay:3-7min	
PROTECTION	Over Voltage(246V±4V),Overload,High Temperature,Short Circuit	
POWER	3000VA	5000VA
PRODUCT SIZE(CM)	39x24.5x10	39x24.5x10
PACKING SIZE(CM)	45x31.5x15.5	45x31.5x15.5
PCS/CARTON	1	1
N.W.(KG)	10.9	11.8
G.W.(KG)	11.3	12.2

LED Display



Switch Button



## TECHNICAL DATA

MODEL	ARS-TMP45 (5000VA-8000VA)	ARS-TMP60 (5000VA-8000VA)	ARS-TMP95 (5000VA-8000VA)
INPUT VOLTAGE	AC 45V-280V	AC 60V-280V	AC 95V-280V
OUTPUT VOLTAGE	AC 220V±10% 50/60Hz		
DELAY TIME	Short Delay:3-5sec Long delay:3-7min		
PROTECTION	Over Voltage(246V±4V),Overload,High Temperature,Short Circuit		
POWER	5000VA	8000VA	
PRODUCT SIZE(CM)	41x29.5x15	41x29.5x15	
PACKING SIZE(CM)	46x34.5x21	46x34.5x21	
PCS/CARTON	1	1	
N.W.(KG)	15.5	17.9	
G.W.(KG)	16.3	18.7	

Widely used in various industries, small office equipment, refrigerator, electric fan, computer, pump, air conditioner, etc.



Washing Maching Fridge Air Conditioner Air compressor Motor Water pump

Relay Control + Toroidal Transformer, Efficiency > 97%



# ARS-TMP<sub>45/60/95</sub>

Series (10KVA-15KVA)



ISO9001



The product of this model is a **220V** fully automatic voltage regulator, both for desktop & wall mounted. With LED digital display design. It is characterized by stable work, high pressure regulation speed and wide voltage regulation range.

### TECHNICAL DATA

MODEL	ARS-TMP45 (10KVA-15KVA)	ARS-TMP60 (10KVA-15KVA)	ARS-TMP95 (10KVA-15KVA)
INPUT VOLTAGE	AC 45V-280V	AC 60V-280V	AC 95V-280V
OUTPUT VOLTAGE	AC 220V±10% 50/60Hz		
DELAY TIME	Short Delay:3-5sec Long Delay:3-7min		
PROTECTION	Over Voltage(246V±4V),Overload,High Temperature,Short Circuit		
POWER	10KVA	12KVA	15KVA
PRODUCT SIZE(CM)	45x31x16.4	45x31x16.4	45x31x16.4
PACKING SIZE(CM)	51.8x38.5x23.7	51.8x38.5x23.7	51.8x38.5x23.7
PCS/CARTON	1	1	1
N.W.(KG)	22	23.4	25.5
G.W.(KG)	23	24.6	26.7

LED Display



Switch Button

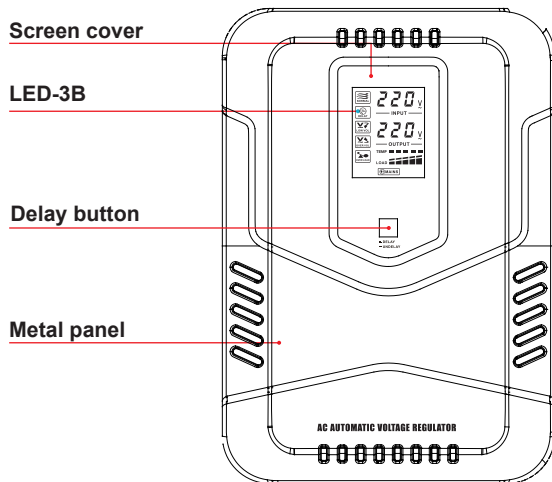

### TECHNICAL DRAWING

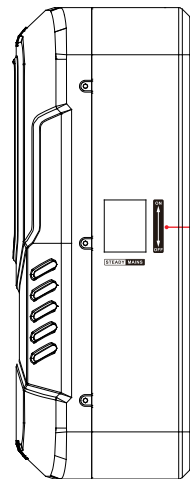

Widely used in various industries, small office equipment, refrigerator, electric fan, computer, pump, air conditioner, etc.



Washing Maching    LCD TV    Rice Cooker    Microwave Oven    Printer    Computer

Relay Control + Toroidal Transformer, Efficiency > 97%

# ARS-TMP<sub>45/60/95</sub>

Series (20KVA)

ISO9001



The product of this model is a **220V** fully automatic voltage regulator, both for desktop & wall mounted. With LED digital display design. It is characterized by stable work, high pressure regulation speed and wide voltage regulation range.



## TECHNICAL DATA

MODEL	ARS-TMP45-20KVA	ARS-TMP60-20KVA	ARS-TMP95-20KVA
INPUT VOLTAGE	AC 45V-280V	AC 60V-280V	AC 95V-280V
OUTPUT VOLTAGE	AC 220V±10% 50/60Hz		
DELAY TIME	Short Delay:3-5sec Long delay:3-7min		
PROTECTION	Over Voltage(246V±4V),Overload,High Temperature,Short Circuit		
POWER	20KVA		
PRODUCT SIZE(CM)	45x31x17.4		
PACKING SIZE(CM)	51.8x38.5x24.7		
PCS/CARTON	1		
N.W.(KG)	28.2		
G.W.(KG)	29.5		

LED Display



Switch Button

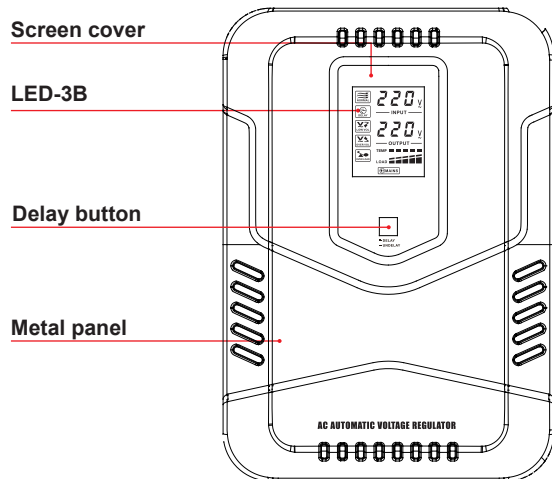

## TECHNICAL DRAWING

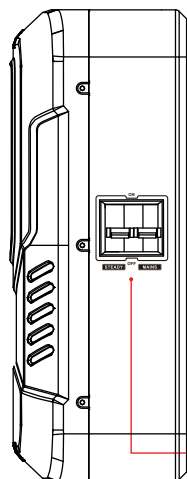

Air switch

Widely used in various industries, small office equipment, refrigerator, electric fan, computer, pump, air conditioner, etc.



Washing Maching Fridge Air Conditioner Air compressor Motor Water pump

Relay Control + Toroidal Transformer, Efficiency > 97%

# ARS-MOU95

Series

(500VA-2000VA)



ISO9001

NORMAL

DELAY

LOW VOL

OVER VOL

OVER LOAD

The product of this model is a 220V fully automatic small-sized voltage regulator, both for desktop and wall mounted. With LED digital display design. It is characterized by small size, light weight, easy to use and install, reliable operation and high pressure regulation speed.

## TECHNICAL DATA

MODEL	ARS-MOU95(500VA-2000VA)			
INPUT VOLTAGE	AC 95V-270V			
OUTPUT VOLTAGE	AC 220V±10% 50/60Hz			
DELAY TIME	Short Delay:3-5sec Long delay:3-7min			
PROTECTION	Over Voltage(246V±4V),Overload,High Temperature,Short Circuit			
POWER	500VA	1000VA	1500VA	2000VA
PRODUCT SIZE(CM)	20x12.7x8.4	21.5x14.2x11.7	21.5x14.2x11.7	23.8x15.7x13.2
PACKING SIZE(CM)	41.5x27.5x23.5	46x29x28.5	46x29x28.5	50.5x31.5x28.5
PCS/CARTON	6	6	6	6
N.W.(KG)	14.4	19.8	22.8	31.8
G.W.(KG)	16.1	21.5	24.5	33.7

LED Display



Air Circulation

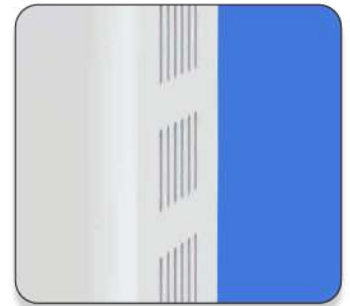

Metal panel

LED-4E

Screen cover

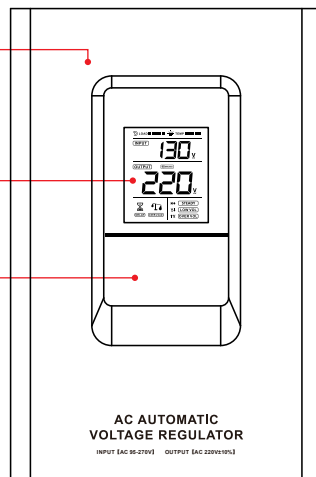

## TECHNICAL DRAWING

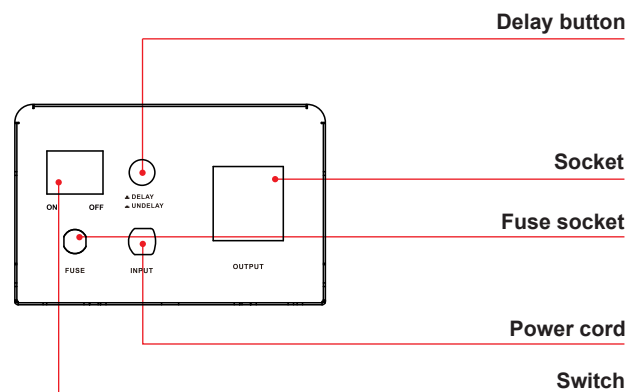

Widely used in various industries, small office equipment, refrigerator, electric fan, computer, pump, air conditioner, etc.



Washing Maching LCD TV Rice Cooker Microwave Oven Printer Computer

Relay Control + Toroidal Transformer, Efficiency > 97%

# ARS-MOU<sub>45/60/95</sub>

Series (3000VA-8000VA)



ISO9001



The product of this model is a 220V fully automatic small-sized voltage regulator, both for desktop and wall mounted. With LED digital display design. It is characterized by small size, light weight, easy to use and install, reliable operation and high pressure regulation speed.

### TECHNICAL DATA

MODEL	ARS-MOU95(3000VA-5000VA)	
INPUT VOLTAGE	AC 95V-270V	
OUTPUT VOLTAGE	AC 220V±10% 50/60Hz	
DELAY TIME	Short Delay:3-5sec Long delay:3-7min	
PROTECTION	Over Voltage(246V±4V),Overload,High Temperature,Short Circuit	
POWER	3000VA	5000VA
PRODUCT SIZE(CM)	39x24.5x10	39x24.5x10
PACKING SIZE(CM)	44x29.5x15.3	44x29.5x15.3
PCS/CARTON	1	1
N.W.(KG)	10.9	11.8
G.W.(KG)	11.3	12.2

LED Display



Switch Button



### TECHNICAL DATA

MODEL	ARS-MOU45 (5000VA-8000VA)	ARS-MOU60 (5000VA-8000VA)	ARS-MOU95 (5000VA-8000VA)
INPUT VOLTAGE	AC 45V-280V	AC 60V-280V	AC 95V-280V
OUTPUT VOLTAGE	AC 220V±10% 50/60Hz		
DELAY TIME	Short Delay:3-5sec Long delay:3-7min		
PROTECTION	Over Voltage(246V±4V),Overload,High Temperature,Short Circuit		
POWER	5000VA	8000VA	
PRODUCT SIZE(CM)	41x29.5x15	41x29.5x15	
PACKING SIZE(CM)	46x34.5x22	46x34.5x22	
PCS/CARTON	1	1	
N.W.(KG)	15.5	17.9	
G.W.(KG)	16.3	18.7	

Widely used in various industries, small office equipment, refrigerator, electric fan, computer, pump, air conditioner, etc.



Washing Maching Fridge Air Conditioner Air compressor Motor Water pump

Relay Control + Toroidal Transformer, Efficiency > 97%

# ARS-MOU<sub>45/60/95</sub> Series (10KVA-15KVA)



ISO9001



The product of this model is a 220V fully automatic small-sized voltage regulator, both for desktop and wall mounted. With LED digital display design. It is characterized by small size, light weight, easy to use and install, reliable operation and high pressure regulation speed.

## TECHNICAL DATA

MODEL	ARS-MOU45 (10KVA-15KVA)	ARS-MOU60 (10KVA-15KVA)	ARS-MOU95 (10KVA-15KVA)
INPUT VOLTAGE	AC 45V-280V	AC 60V-280V	AC 95V-280V
OUTPUT VOLTAGE	AC 220V±10% 50/60Hz		
DELAY TIME	Short Delay:3-5sec Long Delay:3-7min		
PROTECTION	Over Voltage(246V±4V), Overload, High Temperature, Short Circuit		
POWER	10KVA	12KVA	15KVA
PRODUCT SIZE(CM)	45x31x16.4	45x31x16.4	45x31x16.4
PACKING SIZE(CM)	51.8x38.5x23.7	51.8x38.5x23.7	51.8x38.5x23.7
PCS/CARTON	1	1	1
N.W.(KG)	22	23.4	25.5
G.W.(KG)	23	24.6	26.7

LED Display



Switch Button



Screen cover

LED-3G

Metal panel

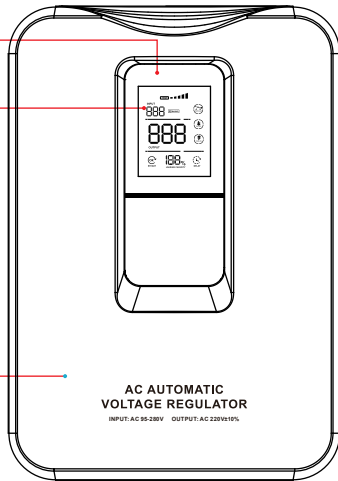

## TECHNICAL DRAWING

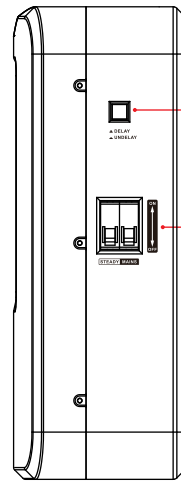

Delay button

Air switch

Widely used in various industries, small office equipment, refrigerator, electric fan, computer, pump, air conditioner, etc.



Washing Maching LCD TV Rice Cooker Microwave Oven Printer Computer

Relay Control + Toroidal Transformer, Efficiency > 97%

# ARS-MOU<sub>45/60/95</sub>

Series (20KVA)



ISO9001



The product of this model is a 220V fully automatic small-sized voltage regulator, both for desktop and wall mounted. With LED digital display design. It is characterized by small size, light weight, easy to use and install, reliable operation and high pressure regulation speed.

## TECHNICAL DATA

MODEL	ARS-MOU45-20KVA	ARS-MOU60-20KVA	ARS-MOU95-20KVA
INPUT VOLTAGE	AC 45V-280V	AC 60V-280V	AC 95V-280V
OUTPUT VOLTAGE	AC 220V±10% 50/60Hz		
DELAY TIME	Short Delay:3-5sec Long delay:3-7min		
PROTECTION	Over Voltage(246V±4V), Overload, High Temperature, Short Circuit		
POWER	20KVA		
PRODUCT SIZE(CM)	45x31x17.4		
PACKING SIZE(CM)	51.8x38.5x24.7		
PCS/CARTON	1		
N.W.(KG)	28.2		
G.W.(KG)	29.5		

LED Display



Switch Button



Screen cover

LED-3G

Metal panel

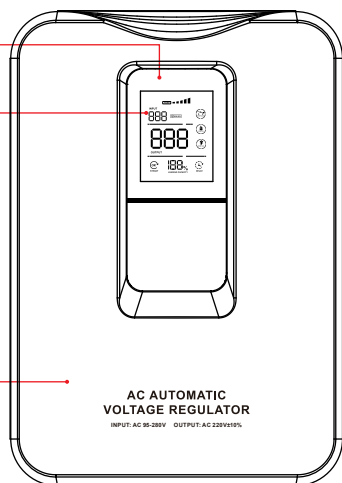

## TECHNICAL DRAWING

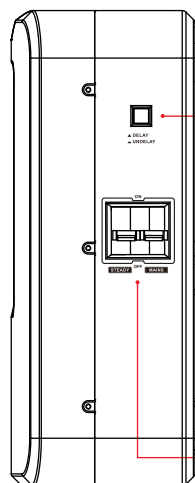

Delay button

Air switch

Widely used in various industries, small office equipment, refrigerator, electric fan, computer, pump, air conditioner, etc.



Washing Maching Fridge Air Conditioner Air compressor Motor Water pump

Relay Control + Toroidal Transformer, Efficiency > 97%

# ARS-MON<sub>45/60/95</sub> Series

(3000VA-8000VA)



ISO9001



The product of this model is a **220V** fully automatic voltage regulator, both for desktop & wall mounted. With LED digital display design. It is characterized by stable work, high pressure regulation speed and wide voltage regulation range.

### TECHNICAL DATA

MODEL	ARS-MON95(3000VA-5000VA)	
INPUT VOLTAGE	AC 95V-270V	
OUTPUT VOLTAGE	AC 220V±10% 50/60Hz	
DELAY TIME	Short Delay:3-5sec Long delay:3-7min	
PROTECTION	Over Voltage(246V±4V),Overload,High Temperature,Short Circuit	
POWER	3000VA	5000VA
PRODUCT SIZE(CM)	39x24.5x10	39x24.5x10
PACKING SIZE(CM)	44x29.5x15.3	44x29.5x15.3
PCS/CARTON	1	1
N.W.(KG)	10.9	11.8
G.W.(KG)	11.3	12.2

LED Display



Switch Button



### TECHNICAL DATA

MODEL	ARS-MON45 (5000VA-8000VA)	ARS-MON60 (5000VA-8000VA)	ARS-MON95 (5000VA-8000VA)
INPUT VOLTAGE	AC 45V-280V	AC 60V-280V	AC 95V-280V
OUTPUT VOLTAGE	AC 220V±10% 50/60Hz		
DELAY TIME	Short Delay:3-5sec Long delay:3-7min		
PROTECTION	Over Voltage(246V±4V),Overload,High Temperature,Short Circuit		
POWER	5000VA	8000VA	
PRODUCT SIZE(CM)	41x29.5x15	41x29.5x15	
PACKING SIZE(CM)	46x34.5x21	46x34.5x21	
PCS/CARTON	1	1	
N.W.(KG)	15.5	17.9	
G.W.(KG)	16.3	18.7	

Widely used in various industries, small office equipment, refrigerator, electric fan, computer, pump, air conditioner, etc.



Washing Maching    LCD TV    Rice Cooker    Microwave Oven    Printer    Computer

Relay Control + Toroidal Transformer, Efficiency > 97%

# ARS-MON<sub>45/60/95</sub> Series (10KVA-15KVA)

ISO9001



The product of this model is a **220V** fully automatic voltage regulator, both for desktop & wall mounted. With LED digital display design. It is characterized by stable work, high pressure regulation speed and wide voltage regulation range.

### TECHNICAL DATA

MODEL	ARS-MON45 (10KVA-15KVA)	ARS-MON60 (10KVA-15KVA)	ARS-MON95 (10KVA-15KVA)
INPUT VOLTAGE	AC 45V-280V	AC 60V-280V	AC 95V-280V
OUTPUT VOLTAGE	AC 220V±10% 50/60Hz		
DELAY TIME	Short Delay:3-5sec Long Delay:3-7min		
PROTECTION	Over Voltage(246V±4V),Overload,High Temperature,Short Circuit		
POWER	10KVA	12KVA	15KVA
PRODUCT SIZE(CM)	45x31x16.4	45x31x16.4	45x31x16.4
PACKING SIZE(CM)	51.8x38.5x23.7	51.8x38.5x23.7	51.8x38.5x23.7
PCS/CARTON	1	1	1
N.W.(KG)	22	23.4	25.5
G.W.(KG)	23	24.6	26.7



LED Display

Switch Button



Screen cover

LED-3L

Metal panel

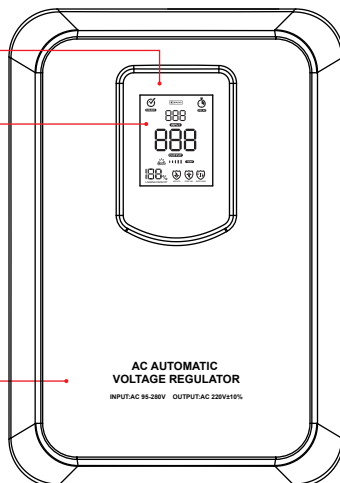

### TECHNICAL DRAWING

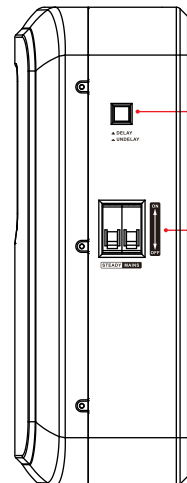

Delay button

Air switch

Widely used in various industries, small office equipment, refrigerator, electric fan, computer, pump, air conditioner, etc.



Washing Maching Fridge Air Conditioner Air compressor Motor Water pump

Relay Control + Toroidal Transformer, Efficiency > 97%



# ARS-MON<sub>45/60/95</sub> Series (20KVA)



ISO9001



The product of this model is a **220V** fully automatic voltage regulator, both for desktop & wall mounted. With LED digital display design. It is characterized by stable work, high pressure regulation speed and wide voltage regulation range.

### TECHNICAL DATA

MODEL	ARS-MON45-20KVA	ARS-MON60-20KVA	ARS-MON95-20KVA
INPUT VOLTAGE	AC 45V-280V	AC 60V-280V	AC 95V-280V
OUTPUT VOLTAGE	AC 220V±10% 50/60Hz		
DELAY TIME	Short Delay:3-5sec Long delay:3-7min		
PROTECTION	Over Voltage(246V±4V), Overload, High Temperature, Short Circuit		
POWER	20KVA		
PRODUCT SIZE(CM)	45x31x17.4		
PACKING SIZE(CM)	51.8x38.5x24.7		
PCS/CARTON	1		
N.W.(KG)	28.2		
G.W.(KG)	29.5		

LED Display



Switch Button



Screen cover

LED-3G

Metal panel

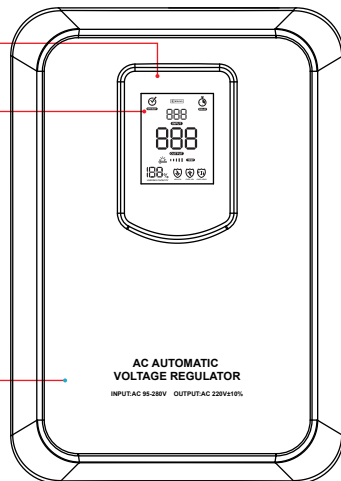

### TECHNICAL DRAWING

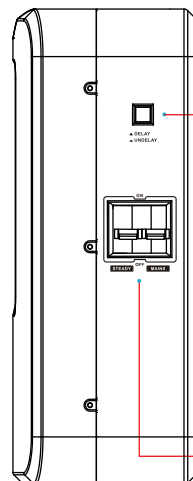

Delay button

Air switch

Widely used in various industries, small office equipment, refrigerator, electric fan, computer, pump, air conditioner, etc.



Washing Maching    LCD TV    Rice Cooker    Microwave Oven    Printer    Computer

Relay Control + Toroidal Transformer, Efficiency > 97%

# ARS-TMN<sub>45/60/95</sub>

Series (5000VA)



ISO9001



The product of this model is a 220V fully automatic small-sized voltage regulator, both for desktop and wall mounted. With LED digital display design. It is characterized by small size, light weight, easy to use and install, reliable operation and high pressure regulation speed.

### TECHNICAL DATA

MODEL	ARS-TMN45-5000VA	ARS-TMN60-5000VA	ARS-TMN95-5000VA
INPUT VOLTAGE	AC 45V-270V	AC 60V-270V	AC 95V-270V
OUTPUT VOLTAGE	AC 220V±10% 50/60Hz		
DELAY TIME	Short Delay:3-5sec Long delay:3-7min		
PROTECTION	Over Voltage(246V±4V),Overload,High Temperature,Short Circuit		
POWER	5000VA		
PRODUCT SIZE(CM)	39x24.5x10		
PACKING SIZE(CM)	44x29.5x15		
PCS/CARTON	1		
N.W.(KG)	11.8		
G.W.(KG)	12.2		

LED Display



Switch Button



Metal panel

Screen cover

LED-4D

Indicator light board

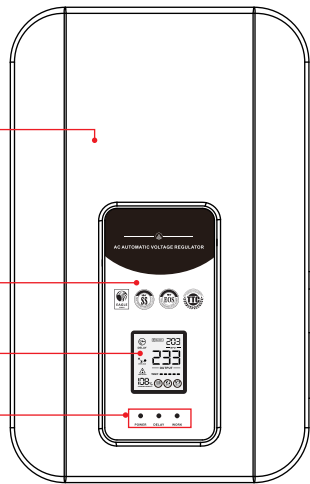

### TECHNICAL DRAWING

Delay button

Air switch

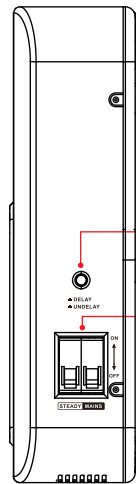

Widely used in various industries, small office equipment, refrigerator, electric fan, computer, pump, air conditioner, etc.



Washing Maching Fridge Air Conditioner Air compressor Motor Water pump

Relay Control + Toroidal Transformer, Efficiency > 97%

# ARS-TMQ<sub>45/60/95</sub>

Series (5000VA-15KVA)



ISO9001



The product of this model is a 220V fully automatic small-sized voltage regulator, both for desktop and wall mounted. With LED digital display design. It is characterized by small size, light weight, easy to use and install, reliable operation and high pressure regulation speed.

### TECHNICAL DATA

MODEL	ARS-TMQ (5KVA-15KVA)	ARS-TMQ45 (5KVA-15KVA)	ARS-TMQ60 (5KVA-15KVA)	ARS-TMQ95 (5KVA-15KVA)
INPUT VOLTAGE	AC 130V-270V	AC 45V-280V	AC 60V-280V	AC 95V-280V
OUTPUT VOLTAGE	AC 220V±10% 50/60Hz			
DELAY TIME	Short Delay:3-5sec			
PROTECTION	Over Voltage(246V±4V),Overload,High Temperature,Short Circuit			
POWER	5000VA	10000VA	12000VA	15000VA
PRODUCT SIZE(CM)	44x32x21	44x32x21	44x32x21	44x32x21
PACKING SIZE(CM)	49.8x37x25.5	49.8x37x25.5	49.8x37x25.5	49.8x37x25.5
PCS/CARTON	1	1	1	1
N.W.(KG)	16.5	22.4	23.2	24.9
G.W.(KG)	17.8	23.7	24.5	26.2

LED Display



Air Circulation



### TECHNICAL DRAWING

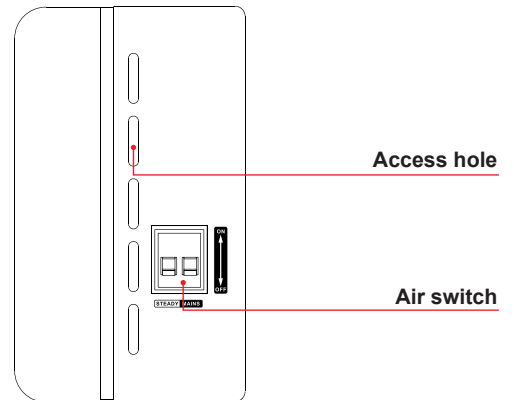
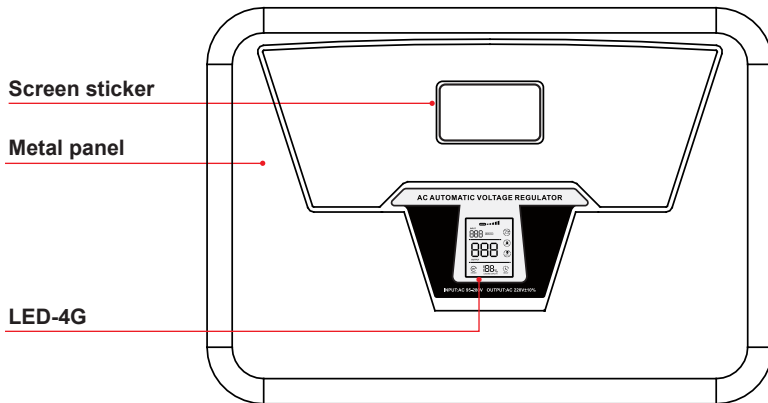

Widely used in various industries, small office equipment, refrigerator, electric fan, computer, pump, air conditioner, etc.



Washing Maching LCD TV Rice Cooker Microwave Oven Printer Computer

Relay Control + Toroidal Transformer, Efficiency > 97%

# ARS-TME / TME95 Series

(3000VA-8000VA)



ISO9001



The product of this model is a **220V** fully automatic voltage regulator, both for desktop & wall mounted. With LED digital display design. It is characterized by stable work, high pressure regulation speed and wide voltage regulation range.

### TECHNICAL DATA

MODEL	ARS-TME-3000VA	ARS-TME95-3000VA
INPUT VOLTAGE	AC 130V-270V	AC 95V-280V
OUTPUT VOITAGE	AC 220V±10% 50/60Hz	
DELAY TIME	Short Delay:3-5sec	
PROTECTION	Over Voltage(246V±4V),Overload,High Temperature,Short Circuit	
POWER	3000VA	
PRODUCT SIZE(CM)	37.7x26.4x14.5	
PACKING SIZE(CM)	42.5x30.5x20	
PCS/CARTON	1	
N.W.(KG)	10.4	
G.W.(KG)	11	

LED Display



Switch Button



### TECHNICAL DATA

MODEL	ARS-TME(5000VA-8000VA)	ARS-TME95(5000VA-8000VA)
INPUT VOLTAGE	AC 130V-270V	AC 95V-280V
OUTPUT VOITAGE	AC 220V±10% 50/60Hz	
DELAY TIME	Short Delay:3-5sec	
PROTECTION	Over Voltage(246V±4V),Overload,High Temperature,Short Circuit	
POWER	5000VA	8000VA
PRODUCT SIZE(CM)	41x29.5x17	41x29.5x17
PACKING SIZE(CM)	46x34.5x23.8	46x34.5x23.8
PCS/CARTON	1	1
N.W.(KG)	15.5	17.9
G.W.(KG)	16.3	18.7

● ● ●  
Widely used in various industries, small office equipment, refrigerator, electric fan, computer, pump, air conditioner, etc.



Washing Maching Fridge Air Conditioner Air compressor Motor Water pump

Relay Control + Toroidal Transformer, Efficiency > 97%

# ARS-TME / TME95 Series (10KVA-15KVA)

ISO9001



The product of this model is a **220V** fully automatic voltage regulator, both for desktop & wall mounted. With LED digital display design. It is characterized by stable work, high pressure regulation speed and wide voltage regulation range.

### TECHNICAL DATA

MODEL	ARS-TME(10KVA-15KVA)	ARS-TME95(10KVA-15KVA)
INPUT VOLTAGE	AC 130V-270V	AC 95V-280V
OUTPUT VOITAGE	AC 220V±10% 50/60Hz	
DELAY TIME	Short Delay:3-5sec	
PROTECTION	Over Voltage(246V±4V),Overload,High Temperature,Short Circuit	
POWER	10000VA	12000VA 15000VA
PRODUCT SIZE(CM)	44x31x20	44x31x20 44x31x20
PACKING SIZE(CM)	49.8x37x25.5	49.8x37x25.5 49.8x37x25.5
PCS/CARTON	1	1 1
N.W.(KG)	21.6	23.3 24.6
G.W.(KG)	23.1	24.7 26



LED Display



Switch Button

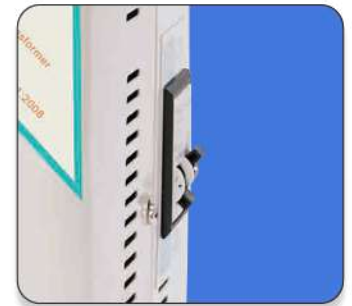

### TECHNICAL DRAWING

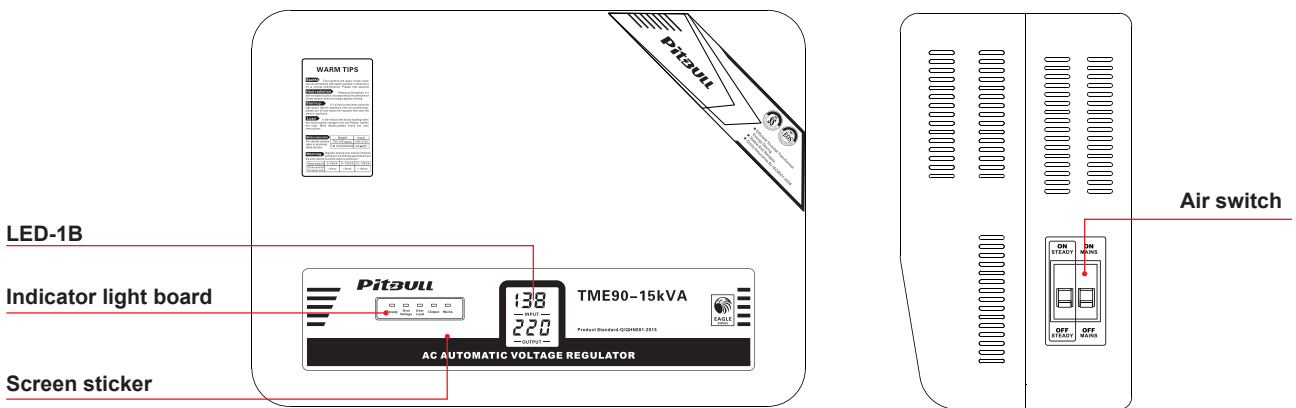

Widely used in various industries, small office equipment, refrigerator, electric fan, computer, pump, air conditioner, etc.



Washing Maching Fridge Air Conditioner Air compressor Motor Water pump

Relay Control + Toroidal Transformer, Efficiency > 97%

# ARS-SMB<sub>45/60/95</sub>

Series (500VA-2000VA)



ISO9001



The product of this model is a **220V** fully automatic small-sized voltage regulator, both for desktop and wall mounted. With LED digital display design. It is characterized by small size, light weight, easy to use and install, reliable operation and high pressure regulation speed.

## TECHNICAL DATA

MODEL	ARS-SMB95(500VA-2000VA)			
INPUT VOLTAGE	AC 95V-270V			
OUTPUT VOLTAGE	AC 220V±10% 50/60Hz			
DELAY TIME	Short Delay:3-5sec Long Delay:3-7min			
PROTECTION	Over Voltage(246V±4V), Overload, High Temperature, Short Circuit			
POWER	500VA	1000VA	1500VA	2000VA
PRODUCT SIZE(CM)	17.5x16.5x12	17.5x16.5x12	17.5x16.5x12	24x16.5x12
PACKING SIZE(CM)	41.4x25.8x33	41.4x25.8x33	41.4x25.8x33	41.4x32.2x33
PCS/CARTON	4	4	4	4
N.W.(KG)	12.8	15	18.8	24.5
G.W.(KG)	14.6	16.4	20.8	26.5

MODEL	ARS-SMB45(1000VA-2000VA)	ARS-SMB60(1000VA-2000VA)
INPUT VOLTAGE	AC 45V-270V	AC 60V-270V
OUTPUT VOLTAGE	AC 220V±10% 50/60Hz	
DELAY TIME	Short Delay:3-5sec Long Delay:3-7min	
PROTECTION	Over Voltage(246V±4V), Overload, High Temperature, Short Circuit	
POWER	1000VA	1500VA
PRODUCT SIZE(CM)	24x16.5x12	26.2x16.5x12
PACKING SIZE(CM)	41.4x32.2x33	41.4x32.2x33
PCS/CARTON	4	4
N.W.(KG)	16	20
G.W.(KG)	17.6	22

Metal panel

LED-1B

Screen cover

Delay button

Switch

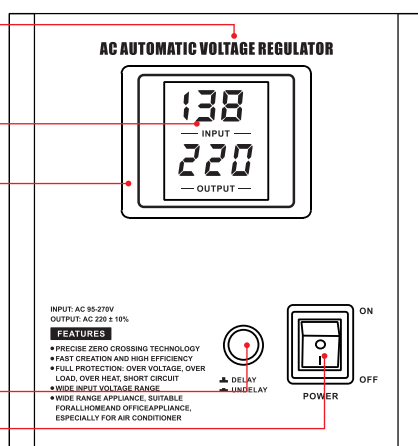

## TECHNICAL DRAWING

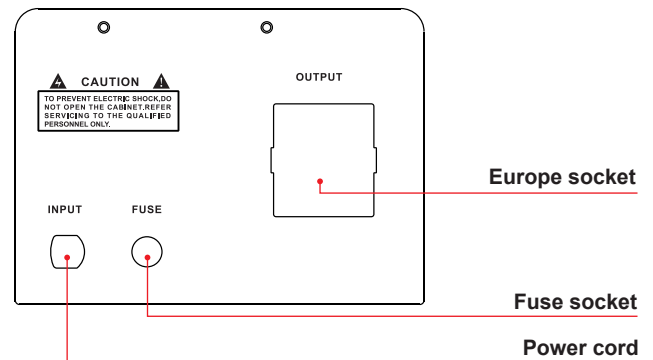

Widely used in various industries, small office equipment, refrigerator, electric fan, computer, pump, air conditioner, etc.



Washing Maching Fridge Air Conditioner Air compressor Motor Water pump

Relay Control + Toroidal Transformer, Efficiency > 97%

# ARS-SMB<sub>45/60/95</sub>

Series (3000VA-5000VA)



ISO9001



The product of this model is a **220V** fully automatic voltage regulator, both for desktop & wall mounted. With LED digital display design. It is characterized by stable work, high pressure regulation speed and wide voltage regulation range.

### TECHNICAL DATA

MODEL	ARS-SMB45-3000VA	ARS-SMB60-3000VA	ARS-SMB95-3000VA
INPUT VOLTAGE	AC 45V-270V	AC 60V-270V	AC 95V-270V
OUTPUT VOITAGE	AC 220V±10% 50/60Hz		
DELAY TIME	Short Delay:3-5sec Long Deley:3-7min		
PROTECTION	Over Voltage(246V±4V),Overload,High Temperature,Short Circuit		
POWER	3000VA		
PRODUCT SIZE(CM)	33x24x14		
PACKING SIZE(CM)	38x29x19		
PCS/CARTON	1		
N.W.(KG)	11.2		
G.W.(KG)	11.8		

LED Display



Switch Button



### TECHNICAL DATA

MODEL	ARS-SMB45-5000VA	ARS-SMB60-5000VA	ARS-SMB95-5000VA
INPUT VOLTAGE	AC 45V-280V	AC 60V-280V	AC 95V-280V
OUTPUT VOLTAGE	AC 220V±10% 50/60Hz		
DELAY TIME	Short Delay:3-5sec Long Deley:3-7min		
PROTECTION	Over Voltage(246V±4V),Overload,High Temperature,Short Circuit		
POWER	5000VA		
PRODUCT SIZE(CM)	36.5x27x17.5		
PACKING SIZE(CM)	41.5x32x23		
PCS/CARTON	1		
N.W.(KG)	15.4		
G.W.(KG)	16.3		

Widely used in various industries, small office equipment, refrigerator, electric fan, computer, pump, air conditioner, etc.



Washing Maching    LCD TV    Rice Cooker    Microwave Oven    Printer    Computer

Relay Control + Toroidal Transformer, Efficiency > 97%

# ARS-SMB<sub>45/60/95</sub>

Series (8KVA-12KVA)



The product of this model is a 220V fully automatic small-sized voltage regulator, both for desktop and wall mounted. With LED digital display design. It is characterized by small size, light weight, easy to use and install, reliable operation and high pressure regulation speed.

### TECHNICAL DATA

MODEL	ARS-SMB45 (8000VA-12KVA)	ARS-SMB60 (8000VA-12KVA)	ARS-SMB95 (8000VA-12KVA)
INPUT VOLTAGE	AC 45V-280V	AC 60V-280V	AC 95V-280V
OUTPUT VOLTAGE	AC 220V±10% 50/60Hz		
DELAY TIME	Short Delay:3-5sec Long Delay:3-7min		
PROTECTION	Over Voltage(246V±4V), Overload, High Temperature, Short Circuit		
POWER	8000VA	10000VA	12000VA
PRODUCT SIZE(CM)	39.5x30x19	39.5x30x19	39.5x30x19
PACKING SIZE(CM)	45x35x25	45x35x25	45x35x25
PCS/CARTON	1	1	1
N.W.(KG)	20	22.6	23.3
G.W.(KG)	21.1	23.8	24.4

LED Display



Switch Button



Screen sticker

LED-2B

Metal panel

Delay button

Air switch

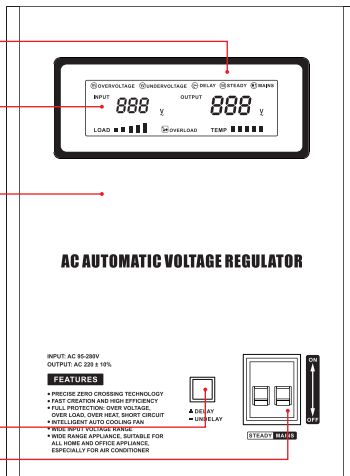

### TECHNICAL DRAWING

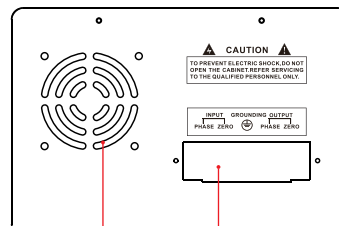

Terminal block

Fan

Widely used in various industries, small office equipment, refrigerator, electric fan, computer, pump, air conditioner, etc.



Washing Maching    LCD TV    Rice Cooker    Microwave Oven    Printer    Computer

Relay Control + Toroidal Transformer, Efficiency > 97%



# ARS-SMB<sub>45/60/95</sub> Series (15KVA-20KVA)



ISO9001



The product of this model is a 220V fully automatic small-sized voltage regulator, both for desktop and wall mounted. With LED digital display design. It is characterized by small size, light weight, easy to use and install, reliable operation and high pressure regulation speed.

### TECHNICAL DATA

MODEL	ARS-SMB45 (15KVA/20KVA)	ARS-SMB60 (15KVA/20KVA)	ARS-SMB95 (15KVA/20KVA)
INPUT VOLTAGE	AC 45V-280V	AC 60V-280V	AC 95V-280V
OUTPUT VOLTAGE	AC 220V±10% 50/60Hz		
DELAY TIME	Short Delay:3-5sec Long Delay:3-7min		
PROTECTION	Over Voltage(246V±4V),Overload,High Temperature,Short Circuit		
POWER	15000VA	20000VA	
PRODUCT SIZE(CM)	30x27x42.5	30x27x42.5	
PACKING SIZE(CM)	36x32.5x51.5	36x32.5x51.5	
PCS/CARTON	1	1	
N.W.(KG)	30.1	32.5	
G.W.(KG)	33.9	36.3	

LED Display



Switch Button



- FEATURES**
- INTELLIGENT AUTO COOLING FAN
  - WIDE INPUT VOLTAGE RANGE
  - WIDE RANGE APPLIANCE SUITABLE FOR ALL HOME AND OFFICE APPLIANCE, ESPECIALLY FOR AIR CONDITIONER
  - PRECISE ZERO CROSSING TECHNOLOGY
  - FAST CREATION AND HIGH EFFICIENCY
  - FULL PROTECTION: OVER VOLTAGE, OVER LOAD, OVER HEAT, SHORT CIRCUIT

LED-2B

Screen sticker

Delay button

Air switch

Metal panel

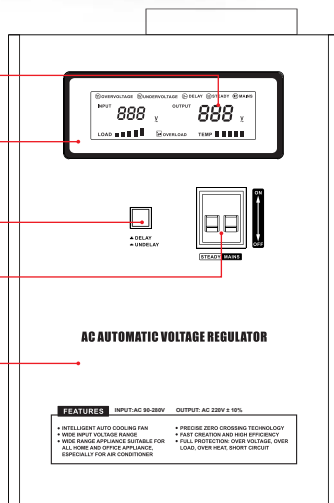

### TECHNICAL DRAWING

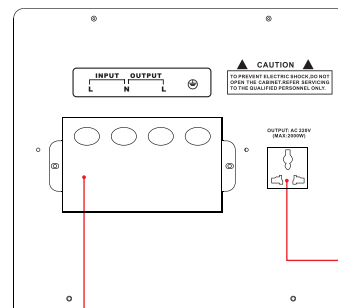

Universal socket

Terminal block

Widely used in various industries, small office equipment, refrigerator, electric fan, computer, pump, air conditioner, etc.



Washing Maching Fridge Air Conditioner Air compressor Motor Water pump

Relay Control + Toroidal Transformer, Efficiency > 97%

# ARS-TM095

Series

(500VA-2000VA)



ISO9001



The product of this model is a 220V fully automatic small-sized voltage regulator, both for desktop and wall mounted. With LED digital display design. It is characterized by small size, light weight, easy to use and install, reliable operation and high pressure regulation speed.

## TECHNICAL DATA

MODEL	ARS-TM095(500VA-2000VA)			
INPUT VOLTAGE	AC 95V-270V			
OUTPUT VOLTAGE	AC 220V±10% 50/60Hz			
DELAY TIME	Short Delay:3-5sec Long delay:3-7min			
PROTECTION	Over Voltage(246V±4V),Overload,High Temperature,Short Circuit			
POWER	500VA	1000VA	1500VA	2000VA
PRODUCT SIZE(CM)	20x12.7x7.6	21.5x14.2x10.1	21.5x14.2x10.1	23.8x15.7x10.2
PACKING SIZE(CM)	41.5x27.5x23.5	46X29X28.5	46X29X28.5	50.5x31.5x28.5
PCS/CARTON	6	6	6	6
N.W.(KG)	14.4	19.8	22.8	31.8
G.W.(KG)	16.1	21.5	24.5	33.7

LED Display



Air Circulation



Metal panel

LED-7A

Screen cover

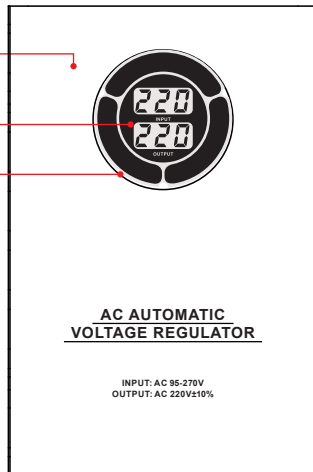

## TECHNICAL DRAWING

Delay button

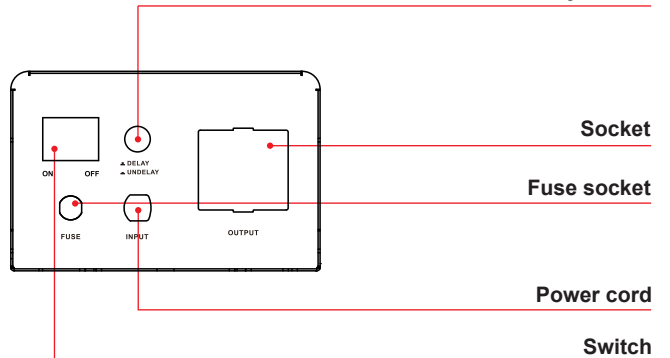

Widely used in various industries, small office equipment, refrigerator, electric fan, computer, pump, air conditioner, etc.



Relay Control + Toroidal Transformer, Efficiency > 97%

# ARS-TMS<sub>45/60/95</sub>

Series (500VA-5000VA)



ISO9001



The product of this model is a 220V fully automatic small-sized voltage regulator, both for desktop and wall mounted. With LED digital display design. It is characterized by small size, light weight, easy to use and install, reliable operation and high pressure regulation speed.

### TECHNICAL DATA

MODEL	ARS-TMS(500VA-2000VA)	ARS-TMS95(500VA-2000VA)		
INPUT VOLTAGE	AC 130V-270V	AC 95V-270V		
OUTPUT VOITAGE	AC 220V±10% 50/60Hz			
DELAY TIME	Short Delay:3-5sec Long delay:3-7min			
PROTECTION	Over Voltage(246V±4V),Overload,High Temperature,Short Circuit			
POWER	500VA	1000VA	1500VA	2000VA
PRODUCT SIZE(CM)	26.3×15.2×8	22.5×16×8.5	28×16×10	28×16×10
PACKING SIZE(CM)	49×36×24	51.5×35×25.5	51.5×37.5×28.5	51.5×37.5×28.5
PCS/CARTON	6	6	6	6
N.W.(KG)	16	24.6	30	34
G.W.(KG)	17.7	26.6	32	35.6

LED Display



Air Circulation

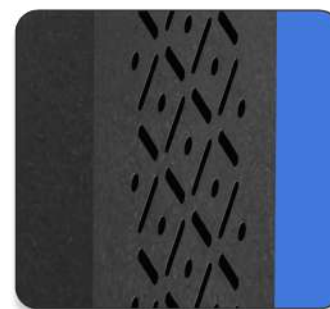

### TECHNICAL DATA

MODEL	ARS-TMS45 (3000VA-5000VA)	ARS-TMS60 (3000VA-5000VA)	ARS-TMS95 (3000VA-5000VA)
INPUT VOLTAGE	AC 45V-270V	AC 60V-270V	AC 95V-270V
OUTPUT VOITAGE	AC 220V±10% 50/60Hz		
DELAY TIME	Short Delay:3-5sec Long delay:3-7min		
PROTECTION	Over Voltage(246V±4V),Overload,High Temperature,Short Circuit		
POWER	3000VA	5000VA	
PRODUCT SIZE(CM)	36×22×12	42×29×14	
PACKING SIZE(CM)	41×27×17	47×34×19.5	
PCS/CARTON	1	1	
N.W.(KG)	9.8	16	
G.W.(KG)	10.3	16.8	

● ● ●  
Widely used in various industries, small office equipment, refrigerator, electric fan, computer, pump, air conditioner, etc.



Washing Maching Fridge Air Conditioner Air compressor Motor Water pump

Relay Control + Toroidal Transformer, Efficiency > 97%

# ARS-TMS<sub>45/60/95</sub>

Series (8KVA-15KVA)



ISO9001



The product of this model is a **220V** fully automatic voltage regulator, both for desktop & wall mounted. With LED digital display design. It is characterized by stable work, high pressure regulation speed and wide voltage regulation range.

### TECHNICAL DATA

MODEL	ARS-TMS45 (8KVA-15KVA)	ARS-TMS60 (8KVA-15KVA)	ARS-TMS95 (8KVA-15KVA)
INPUT VOLTAGE	AC 45V-270V	AC 60V-270V	AC 95V-270V
OUTPUT VOITAGE	AC 220V±10% 50/60Hz		
DELAY TIME	Short Delay:3-5sec Long delay:3-7min		
PROTECTION	Over Voltage(246V±4V),Overload,High Temperature,Short Circuit		
POWER	8000VA	10000VA	12000VA 15000VA
PRODUCT SIZE(CM)	46×32×17.5	46×32×17.5	46×32×17.5 46×32×18.5
PACKING SIZE(CM)	51×37×23.3	51×37×23.3	51×37×23.3 51×37×24.3
PCS/CARTON	1	1	1 1
N.W.(KG)	18.6	23	24 24.8
G.W.(KG)	19.4	24	25 25.8

LED Display



Air Circulation

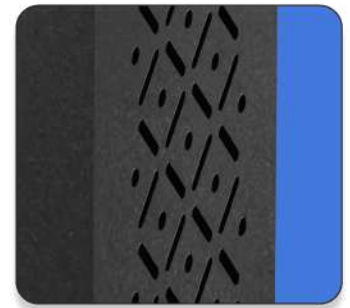

LED-3D

Screen cover

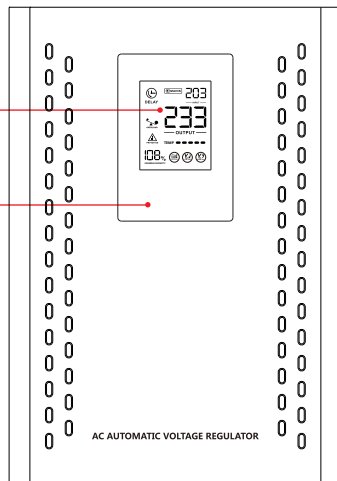

### TECHNICAL DRAWING

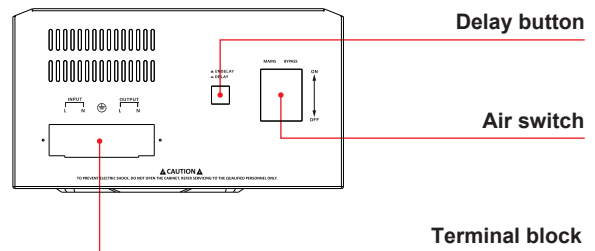

Widely used in various industries, small office equipment, refrigerator, electric fan, computer, pump, air conditioner, etc.



Washing Maching LCD TV Rice Cooker Microwave Oven Printer Computer

Relay Control + Toroidal Transformer, Efficiency > 97%

# ARS-TMS<sub>45/60/95</sub> Series (20KVA-30KVA)



ISO9001



The product of this model is a **220V** fully automatic voltage regulator, both for desktop & wall mounted. With LED digital display design. It is characterized by stable work, high pressure regulation speed and wide voltage regulation range.

## TECHNICAL DATA

MODEL	ARS-TMS45 (20KVA-30KVA)	ARS-TMS60 (20KVA-30KVA)	ARS-TMS95 (20KVA-30KVA)
INPUT VOLTAGE	AC 45V-280V	AC 60V-280V	AC 95V-280V
OUTPUT VOITAGE	AC 220V±10% 50/60Hz		
DELAY TIME	Short Delay:3-5sec Long delay:3-7min		
PROTECTION	Over Voltage(246V±4V),Overload,High Temperature,Short Circuit		
POWER	20KVA	30KVA	
PRODUCT SIZE(CM)	37.5x33x37	44x40x48	
PACKING SIZE(CM)	43x38.5x47.5	49.5x45.5x58.5	
PCS/CARTON	1	1	
N.W.(KG)	32.8	50	
G.W.(KG)	38.7	60.5	

LED Display



Switch Button



## TECHNICAL DRAWING

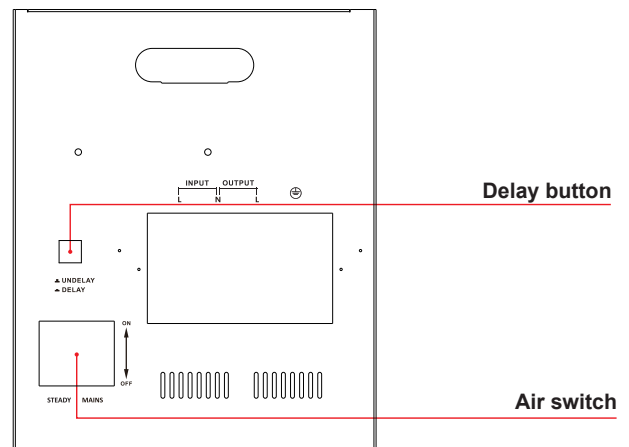
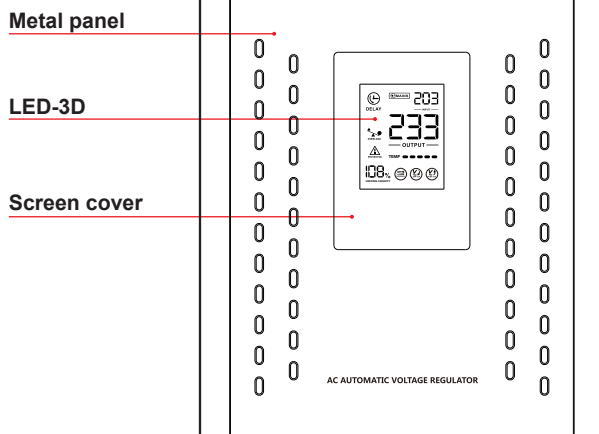

Widely used in various industries, small office equipment, refrigerator, electric fan, computer, pump, air conditioner, etc.



Washing Maching Fridge Air Conditioner Air compressor Motor Water pump

Relay Control + Toroidal Transformer, Efficiency > 97%

# ARS-TMH-A 45/60/95

Series (5000VA-30KVA)



ISO9001



The product of this model is a **220V** fully automatic voltage regulator, both for desktop & wall mounted. With LED digital display design. It is characterized by stable work, high pressure regulation speed and wide voltage regulation range.

### TECHNICAL DATA

MODEL	ARS-TMH-A45 (5KVA-30KVA)	ARS-TMH-A60 (5KVA-30KVA)	ARS-TMH-A95 (5KVA-30KVA)		
INPUT VOLTAGE	AC 45V-280V	AC 60V-280V	AC 95V-280V		
OUTPUT VOITAGE	AC 220V±10% 50/60Hz				
DELAY TIME	Short Delay:3-5sec Long delay:3-7min				
PROTECTION	Over Voltage(246V±4V),Overload,High Temperature,Short Circuit				
POWER	5KVA	10KVA	15KVA	20KVA	30KVA
PRODUCT SIZE(CM)	30x36.5x32	30x36.5x32	37.5x39x39	37.5x39x39	41.5x45x54
PACKING SIZE(CM)	42x35.5x41	42x35.5x41	45x43x46.5	45x43x46.5	50.5x47x67
PCS/CARTON	1	1	1	1	1
N.W.(KG)	17.5	25.7	29.2	32.8	50
G.W.(KG)	23.3	31.3	35.2	48.7	60.5

LED Display



Switch Button



### TECHNICAL DRAWING

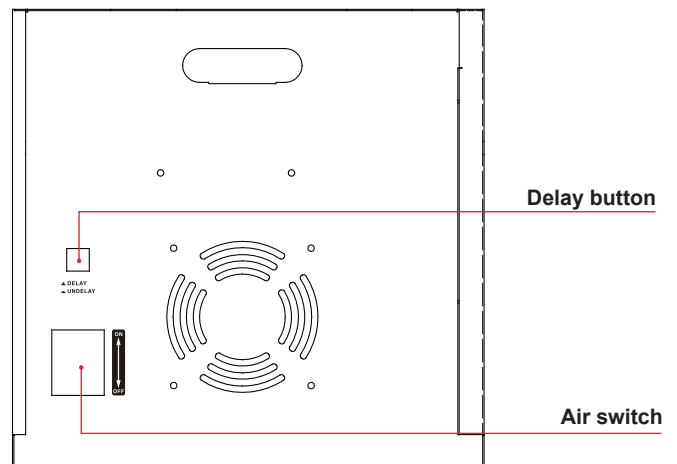
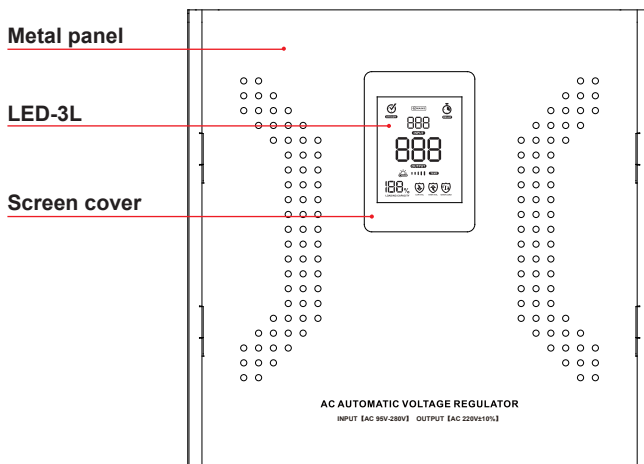

Widely used in various industries, small office equipment, refrigerator, electric fan, computer, pump, air conditioner, etc.



Washing Maching LCD TV Rice Cooker Microwave Oven Printer Computer

Relay Control + Toroidal Transformer, Efficiency > 97%

# ARS-COC 45/60/95

Series (500VA-2000VA)



ISO9001



The product of this model is a 220V fully automatic small-sized voltage regulator, both for desktop and wall mounted. With LED digital display design. It is characterized by small size, light weight, easy to use and install, reliable operation and high pressure regulation speed.

### TECHNICAL DATA

MODEL	ARS-COC45 (500VA-2000VA)	ARS-COC60 (500VA-2000VA)	ARS-COC95 (500VA-2000VA)	
INPUT VOLTAGE	AC 45V-270V	AC 60V-270V	AC 95V-270V	
OUTPUT VOLTAGE	AC 220V±10% 50/60Hz			
DELAY TIME	Short Delay:3-5sec Long delay:3-7min			
PROTECTION	Over Voltage(246V±4V), Overload, High Temperature, Short Circuit			
POWER	500VA	1000VA	1500VA	2000VA
PRODUCT SIZE(CM)	25.5x16x8.5	25.5x16x8.5	28x16x10	28x16x10
PACKING SIZE(CM)	51.5x35x25.5	51.5x35x25.5	51.5x37.5x28.5	51.5x37.5x28.5
PCS/CARTON	6	6	6	6
N.W.(KG)	16	21.2	25.2	34
G.W.(KG)	17.7	23	27.2	35.6

LED Display



Air Circulation

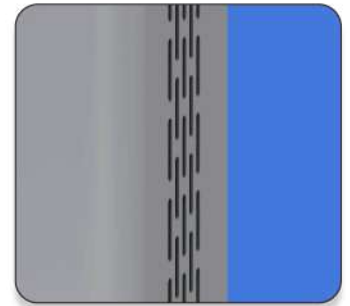

Metal panel

LED-4G

Screen cover

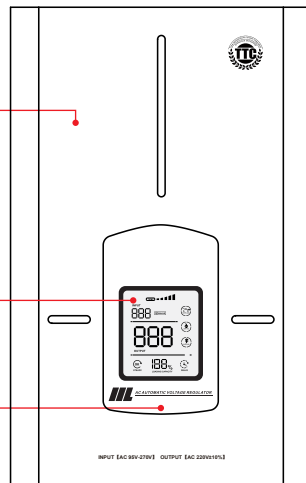

### TECHNICAL DRAWING

Delay button

Switch

Fuse socket

Power cord

Socket

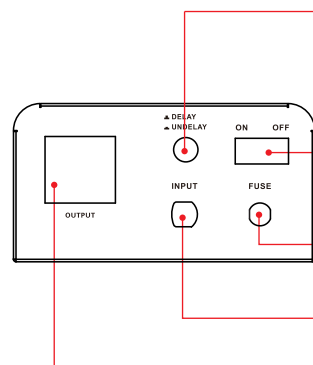

Widely used in various industries, small office equipment, refrigerator, electric fan, computer, pump, air conditioner, etc.



Washing Maching Fridge Air Conditioner Air compressor Motor Water pump

Relay Control + Toroidal Transformer, Efficiency > 97%

# ARS-COC 45/60/95 Series (3000VA-5000VA)



ISO9001



The product of this model is a **220V** fully automatic voltage regulator, both for desktop & wall mounted. With LED digital display design. It is characterized by stable work, high pressure regulation speed and wide voltage regulation range.

### TECHNICAL DATA

MODEL	ARS-COC45-3000VA	ARS-COC60-3000VA	ARS-COC95-3000VA
INPUT VOLTAGE	AC 45V-270V	AC 60V-270V	AC 95V-270V
OUTPUT VOLTAGE	AC 220V±10% 50/60Hz		
DELAY TIME	Short Delay:3-5sec Long Deley:3-7min		
PROTECTION	Over Voltage(246V±4V),Overload,High Temperature,Short Circuit		
POWER	3000VA		
PRODUCT SIZE(CM)	36x22x12		
PACKING SIZE(CM)	41x27x17		
PCS/CARTON	1		
N.W.(KG)	9.3		
G.W.(KG)	9.8		

LED Display



Air Circulation

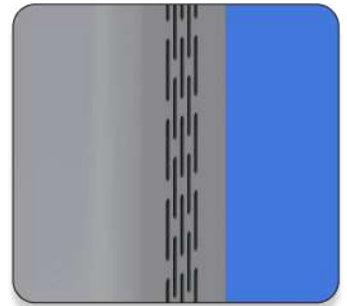

### TECHNICAL DATA

MODEL	ARS-COC45-5000VA	ARS-COC60-5000VA	ARS-COC95-5000VA
INPUT VOLTAGE	AC 45V-280V	AC 60V-280V	AC 95V-280V
OUTPUT VOLTAGE	AC 220V±10% 50/60Hz		
DELAY TIME	Short Delay:3-5sec Long Deley:3-7min		
PROTECTION	Over Voltage(246V±4V),Overload,High Temperature,Short Circuit		
POWER	5000VA		
PRODUCT SIZE(CM)	42x29x14		
PACKING SIZE(CM)	47x34x19.5		
PCS/CARTON	1		
N.W.(KG)	15.5		
G.W.(KG)	16.8		

Widely used in various industries, small office equipment, refrigerator, electric fan, computer, pump, air conditioner, etc.



Washing Maching    LCD TV    Rice Cooker    Microwave Oven    Printer    Computer

Relay Control + Toroidal Transformer, Efficiency > 97%



# ARS-COC 45/60/95 Series (8000VA-12KVA)



ISO9001



The product of this model is a **220V** fully automatic voltage regulator, both for desktop & wall mounted. With LED digital display design. It is characterized by stable work, high pressure regulation speed and wide voltage regulation range.

### TECHNICAL DATA

MODEL	ARS-COC45 (8000VA-12KVA)	ARS-COC60 (8000VA-12KVA)	ARS-COC95 (8000VA-12KVA)
INPUT VOLTAGE	AC 45V-280V	AC 60V-280V	AC 95V-280V
OUTPUT VOLTAGE	AC 220V±10% 50/60Hz		
DELAY TIME	Short Delay:3-5sec Long Delay:3-7min		
PROTECTION	Over Voltage(246V±4V), Overload, High Temperature, Short Circuit		
POWER	8000VA	10000VA	12000VA
PRODUCT SIZE(CM)	46x32x17.5	46x32x17.5	46x32x17.5
PACKING SIZE(CM)	51x37x23.3	51x37x23.3	51x37x23.3
PCS/CARTON	1	1	1
N.W.(KG)	18.6	23	23.8
G.W.(KG)	19.4	24	24.8

LED Display



Air Circulation

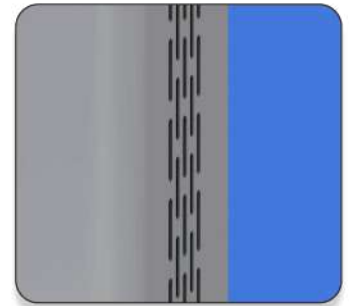

Screen cover

LED-3G

Metal panel

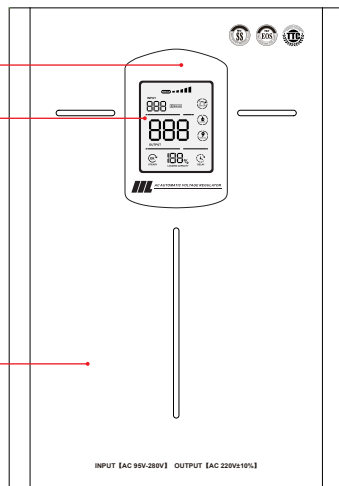

### TECHNICAL DRAWING

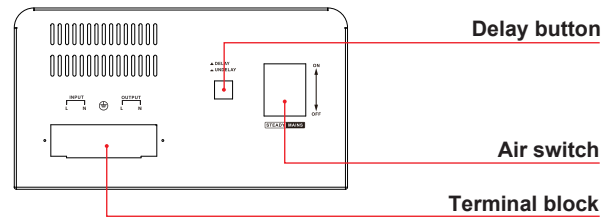

Widely used in various industries, small office equipment, refrigerator, electric fan, computer, pump, air conditioner, etc.



Washing Maching Fridge Air Conditioner Air compressor Motor Water pump

Relay Control + Toroidal Transformer, Efficiency > 97%

# ARS-COC 45/60/95 Series (15KVA-20KVA)



ISO9001



The product of this model is a **220V** fully automatic voltage regulator, both for desktop & wall mounted. With LED digital display design. It is characterized by stable work, high pressure regulation speed and wide voltage regulation range.

## TECHNICAL DATA

MODEL	ARS-COC45 (15KVA/20KVA)	ARS-COC60 (15KVA/20KVA)	ARS-COC95 (15KVA/20KVA)
INPUT VOLTAGE	AC 45V-280V	AC 60V-280V	AC 95V-280V
OUTPUT VOLTAGE	AC 220V±10% 50/60Hz		
DELAY TIME	Short Delay:3-5sec Long Delay:3-7min		
PROTECTION	Over Voltage(246V±4V), Overload, High Temperature, Short Circuit		
POWER	15000VA	20000VA	
PRODUCT SIZE(CM)	30x27x42.5	30x27x42.5	
PACKING SIZE(CM)	36x32.5x51.5	36x32.5x51.5	
PCS/CARTON	1	1	
N.W.(KG)	29.3	31.6	
G.W.(KG)	33.1	35.4	

LED Display



Switch Button



Metal panel

LED-3G

Delay button

Screen cover

Air switch

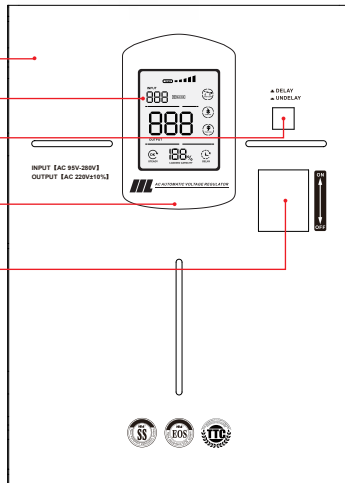

## TECHNICAL DRAWING

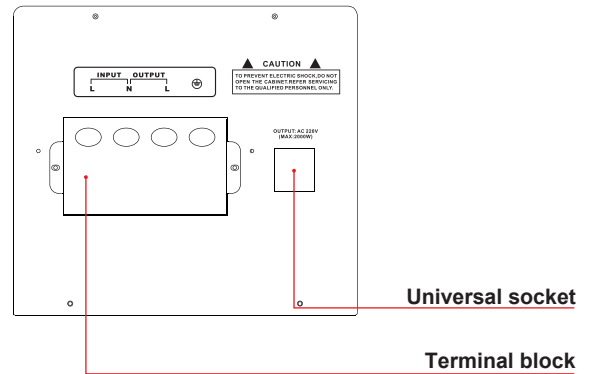

Widely used in various industries, small office equipment, refrigerator, electric fan, computer, pump, air conditioner, etc.



Relay Control + Toroidal Transformer, Efficiency > 97%

# ARS-CLS 45/60/95

Series (10KVA-12KVA)



ISO9001

NORMAL

DELAY

LOW VOL

OVER VOL

OVER LOAD

The product of this model is a **220V** fully automatic voltage regulator, both for desktop & wall mounted. With LED digital display design. It is characterized by stable work, high pressure regulation speed and wide voltage regulation range.

### TECHNICAL DATA

MODEL	ARS-CLS45 (10KVA-12KVA)	ARS-CLS60 (10KVA-12KVA)	ARS-CLS95 (10KVA-12KVA)
INPUT VOLTAGE	AC 45V-280V	AC 60V-280V	AC 95V-280V
OUTPUT VOLTAGE	AC 220V±10% 50/60Hz		
DELAY TIME	Short Delay:3-5sec Long delay:3-7min		
PROTECTION	Over Voltage(246V±4V),Overload,High Temperature,Short Circuit		
POWER	10000VA	12000VA	
PRODUCT SIZE(CM)	46x32x17.5	46x32x17.5	
PACKING SIZE(CM)	51x37x23.3	51x37x23.3	
PCS/CARTON	1	1	
N.W.(KG)	23	23.8	
G.W.(KG)	24	24.8	

LED Display



Air Circulation

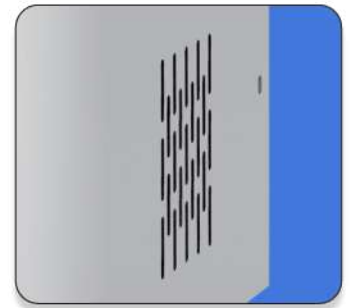

LED-3H  
Screen cover  
Metal panel

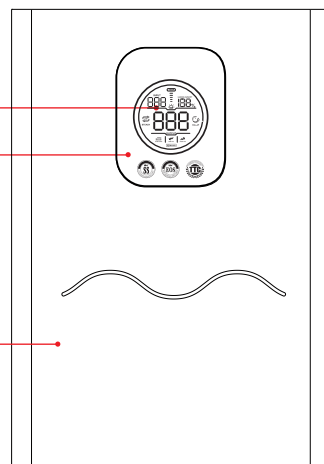

### TECHNICAL DRAWING

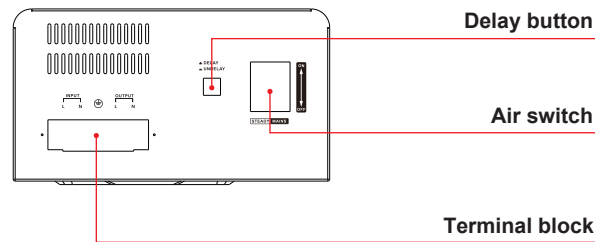

Widely used in various industries, small office equipment, refrigerator, electric fan, computer, pump, air conditioner, etc.



Washing Maching Fridge Air Conditioner Air compressor Motor Water pump

Relay Control + Toroidal Transformer, Efficiency > 97%

# ARS-CLS 45/60/95 Series (15KVA-20KVA)



ISO9001



The product of this model is a **220V** fully automatic voltage regulator, both for desktop & wall mounted. With LED digital display design. It is characterized by stable work, high pressure regulation speed and wide voltage regulation range.

## TECHNICAL DATA

MODEL	ARS-CLS45 (15KVA-20KVA)	ARS-CLS60 (15KVA-20KVA)	ARS-CLS95 (15KVA-20KVA)
INPUT VOLTAGE	AC 45V-280V	AC 60V-280V	AC 95V-280V
OUTPUT VOLTAGE	AC 220V±10% 50/60Hz		
DELAY TIME	Short Delay:3-5sec Long delay:3-7min		
PROTECTION	Over Voltage(246V±4V),Overload,High Temperature,Short Circuit		
POWER	15000VA	20000VA	
PRODUCT SIZE(CM)	37.5x33x37	37.5x33x37	
PACKING SIZE(CM)	43x38.5x47.5	43x38.5x47.5	
PCS/CARTON	1	1	
N.W.(KG)	29.2	32.8	
G.W.(KG)	35.2	38.7	

LED Display



Switch Button



## TECHNICAL DRAWING

Metal panel

LED-3H

Screen cover

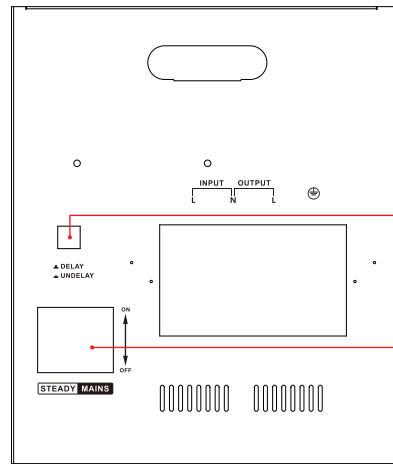
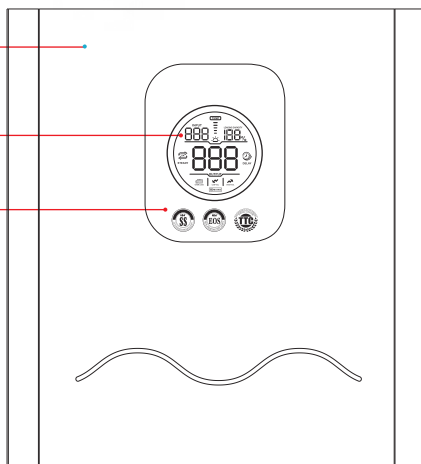

Delay button

Air switch

Widely used in various industries, small office equipment, refrigerator, electric fan, computer, pump, air conditioner, etc.



Washing Maching LCD TV Rice Cooker Microwave Oven Printer Computer

Relay Control + Toroidal Transformer, Efficiency > 97%

# ARS-SSS95

Series (1000VA-2000VA)



ISO9001



The product of this model is a **220V** fully automatic voltage regulator, both for desktop & wall mounted. With LED digital display design. It is characterized by stable work, high pressure regulation speed and wide voltage regulation range.

## TECHNICAL DATA

MODEL	ARS-SSS95(1000VA-2000VA)		
INPUT VOLTAGE	AC 95V-270V		
OUTPUT VOLTAGE	AC 220V±10% 50/60Hz		
DELAY TIME	Short Delay:3-5sec Long delay:3-7min		
PROTECTION	Over Voltage(246V±4V),Overload,High Temperature,Short Circuit		
POWER	1000VA	1500VA	2000VA
PRODUCT SIZE(CM)	24x15x16	24x15x16	26.5x16x17
PACKING SIZE(CM)	32.8x32.5x40.5	32.8x32.5x40.5	35.3x34.5x42.5
PCS/CARTON	4	4	4
N.W.(KG)	15.6	20	24
G.W.(KG)	16.9	21.3	25.3

LED Display



Air Circulation

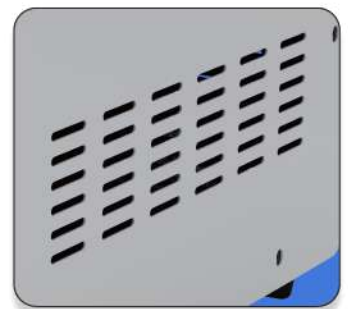

## TECHNICAL DRAWING

Screen cover

LED-4G

Metal panel

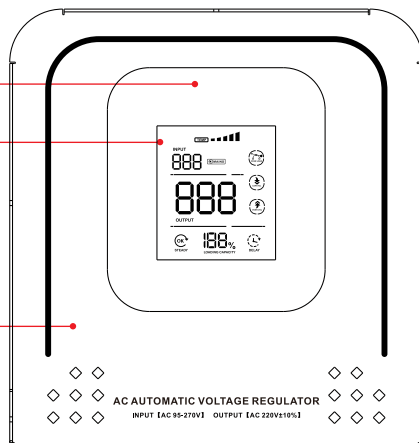

Switch

Socket

Delay button

Power cord

Fuse socket

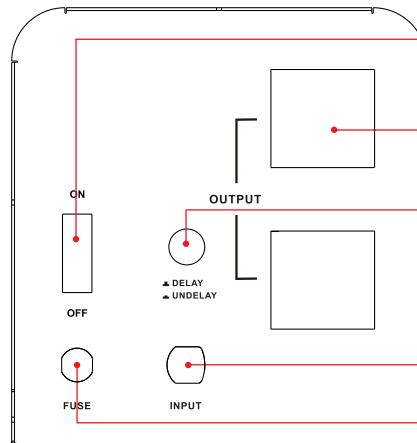

Widely used in various industries, small office equipment, refrigerator, electric fan, computer, pump, air conditioner, etc.



Washing Maching Fridge Air Conditioner Air compressor Motor Water pump

Relay Control + Toroidal Transformer, Efficiency > 97%

# ARS-SSS 45/60/95

Series (3000VA-5000VA)



ISO9001



The product of this model is a **220V** fully automatic voltage regulator, both for desktop & wall mounted. With LED digital display design. It is characterized by stable work, high pressure regulation speed and wide voltage regulation range.

## TECHNICAL DATA

MODEL	ARS-SSS95(3000VA-5000VA)	
INPUT VOLTAGE	AC 95V-270V	
OUTPUT VOLTAGE	AC 220V±10% 50/60Hz	
DELAY TIME	Short Delay:3-5sec Long delay:3-7min	
PROTECTION	Over Voltage(246V±4V),Overload,High Temperature,Short Circuit	
POWER	3000VA	5000VA
PRODUCT SIZE(CM)	36x21x23	36x21x23
PACKING SIZE(CM)	41x26x28.5	41x26x28.5
PCS/CARTON	1	1
N.W.(KG)	9.9	12
G.W.(KG)	10.4	12.5

LED Display



Air Circulation

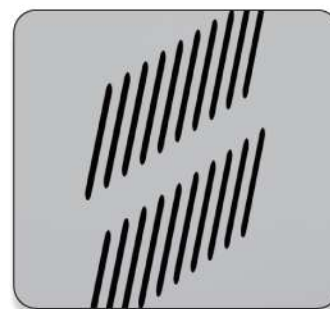

## TECHNICAL DATA

MODEL	ARS-SSS45-5000VA	ARS-SSS60-5000VA	ARS-SSS95-5000VA
INPUT VOLTAGE	AC 45V-280V	AC 60V-280V	AC 95V-280V
OUTPUT VOLTAGE	AC 220V±10% 50/60Hz		
DELAY TIME	Short Delay:3-5sec Long Delay:3-7min		
PROTECTION	Over Voltage(246V±4V),Overload,High Temperature,Short Circuit		
POWER	5000VA		
PRODUCT SIZE(CM)	39x22x25		
PACKING SIZE(CM)	44x27x30.5		
PCS/CARTON	1		
N.W.(KG)	16		
G.W.(KG)	16.5		

Widely used in various industries, small office equipment, refrigerator, electric fan, computer, pump, air conditioner, etc.



Washing Maching LCD TV Rice Cooker Microwave Oven Printer Computer

Relay Control + Toroidal Transformer, Efficiency > 97%

# ARS-SSS 45/60/95 Series (10KVA-20KVA)



ISO9001



The product of this model is a **220V** fully automatic voltage regulator, both for desktop & wall mounted. With LED digital display design. It is characterized by stable work, high pressure regulation speed and wide voltage regulation range.

## TECHNICAL DATA

MODEL	ARS-SSS95(10KVA-20KVA)		
INPUT VOLTAGE	AC 95V-280V		
OUTPUT VOLTAGE	AC 220V±10% 50/60Hz		
DELAY TIME	Short Delay:3-5sec Long Deley:3-7min		
PROTECTION	Over Voltage(246V±4V),Overload,High Temperature,Short Circuit		
POWER	10000VA	15000VA	20000VA
PRODUCT SIZE(CM)	37.8x26.5x32	37.8x26.5x32	37.8x26.5x32
PACKING SIZE(CM)	42.8x31.5x38.2	42.8x31.5x38.2	42.8x31.5x38.2
PCS/CARTON	1	1	1
N.W.(KG)	23	25.4	27.5
G.W.(KG)	24	26.4	28.5

MODEL	ARS-SSS45(10KVA-20KVA)	ARS-SSS60(10KVA-20KVA)
INPUT VOLTAGE	AC 45V-280V	AC 60V-280V
OUTPUT VOLTAGE	AC 220V±10% 50/60Hz	
DELAY TIME	Short Delay:3-5sec Long Deley:3-7min	
PROTECTION	Over Voltage(246V±4V),Overload,High Temperature,Short Circuit	
POWER	10000VA	15000VA
PRODUCT SIZE(CM)	42.8x26.5x32	42.8x26.5x32
PACKING SIZE(CM)	47.8x31.5x38.2	47.8x31.5x38.2
PCS/CARTON	1	1
N.W.(KG)	24.5	26
G.W.(KG)	25.5	27

## TECHNICAL DRAWING

Screen cover

LED-3G

Metal panel

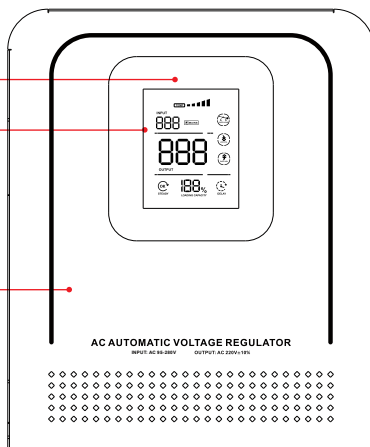

Delay button

Air switch

USB

Universal socket

Terminal block

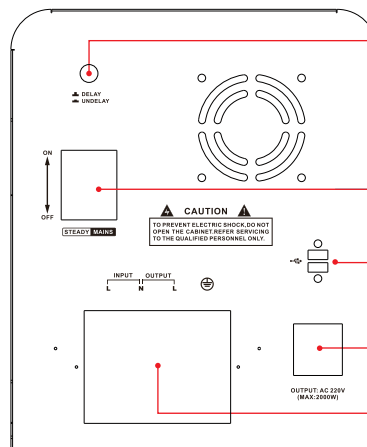

Widely used in various industries, small office equipment, refrigerator, electric fan, computer, pump, air conditioner, etc.



Washing Maching Fridge Air Conditioner Air compressor Motor Water pump

Relay Control + Toroidal Transformer, Efficiency > 97%

# ARS-SAE/SAE95

Series (500VA-2000VA)



ISO9001



The product of this model is a 220V fully automatic small-sized voltage regulator, which is a portable LED digital display design. It is characterized by small size, light weight, high voltage regulation speed and no waveform distortion.

## TECHNICAL DATA

MODEL	ARS-SAE(500VA-2000VA)	ARS-SAE95(500VA-2000VA)		
INPUT VOLTAGE	AC 130V-270V	AC 95V-270V		
OUTPUT VOITAGE	AC 220V±10% 50/60Hz			
DELAY TIME	Short Delay:3-5sec Long Deley:3-7min			
PROTECTION	Over Voltage(246V±4V),Overload,High Temperature,Short Circuit			
POWER	500VA	1000VA	1500VA	2000VA
PRODUCT SIZE(CM)	30x15.5x20	30x15.5x20	30x15.5x20	30x15.5x20
PACKING SIZE(CM)	39.5x35x50	39.5x35x50	39.5x35x50	39.5x35x50
PCS/CARTON	4	4	4	4
N.W.(KG)	10.3	13.3	17.5	20
G.W.(KG)	12.3	15.3	19.5	21.9

LED Display



Power Button



## TECHNICAL DRAWING

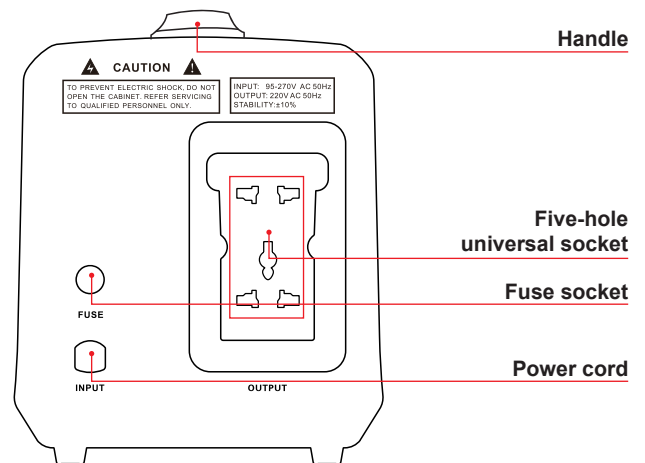
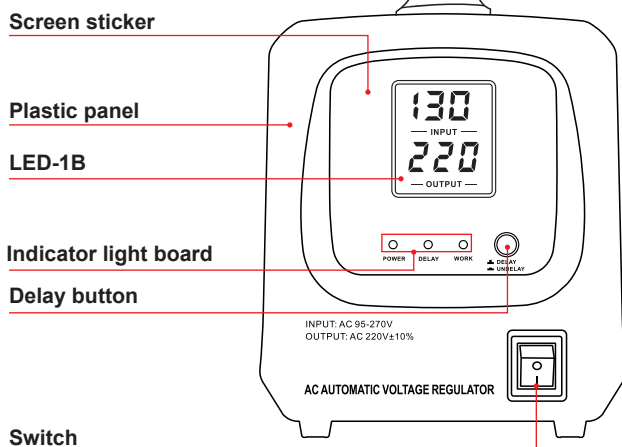

Widely used in various industries, small office equipment, refrigerator, electric fan, computer, pump, air conditioner, etc.



Washing Maching LCD TV Rice Cooker Microwave Oven Printer Computer

Relay Control + Toroidal Transformer, Efficiency > 97%



# ARS-SAE/SAE95 Series (3000VA-5000VA)



ISO9001



The product of this model is a 220V fully automatic voltage regulator, with LED digital display design, USB charging interface, it is characterized by stable work, high pressure regulation speed and wide range.

## TECHNICAL DATA

MODEL	ARS-SAE(3000VA-5000VA)	ARS-SAE95(3000VA-5000VA)
INPUT VOLTAGE	AC 130V-270V	AC 95V-270V
OUTPUT VOITAGE	AC 220V±10% 50/60Hz	
DELAY TIME	Short Delay:3-5sec Long Deley:3-7min	
PROTECTION	Over Voltage(246V±4V),Overload,High Temperature,Short Circuit	
POWER	3000VA	5000VA
PRODUCT SIZE(CM)	38.1x22x26.5	38.1x22x26.5
PACKING SIZE(CM)	46x27.5x32.5	46x27.5x32.5
PCS/CARTON	1	1
N.W.(KG)	11.2	15.4
G.W.(KG)	12.4	16.6



LED Display



Indicator Light



## TECHNICAL DRAWING

Screen sticker

LED-4B

Metal panel

Indicator light board

Delay button

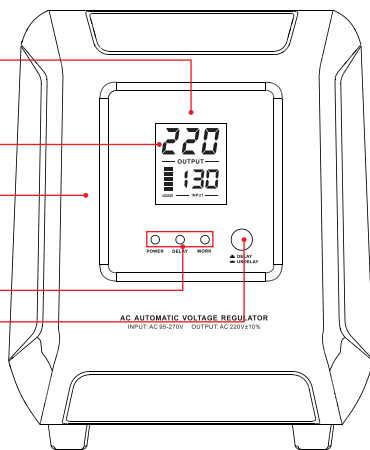

Fan

Five-hole universal socket

USB assembly

Air switch

Grounding terminal

Input/output terminal

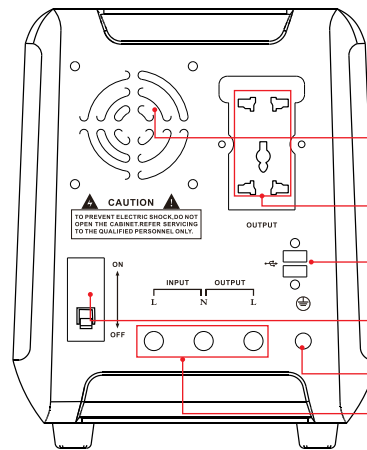

Widely used in various industries, small office equipment, refrigerator, electric fan, computer, pump, air conditioner, etc.



Washing Maching Fridge Air Conditioner Air compressor Motor Water pump

Relay Control + Toroidal Transformer, Efficiency > 97%

# ARS-SAE/SAE95

Series (8000VA-20KVA)



Black



Red



Blue



Green

ISO9001



The product of this model is a 220V fully automatic voltage regulator, with LED digital display design, USB charging interface, it is characterized by stable lower voltage, high pressure regulation speed, wide range and high efficiency.

### TECHNICAL DATA

MODEL	ARS-SAE(8000VA-20KVA)	ARS-SAE95(8000VA-20KVA)		
INPUT VOLTAGE	AC 130V-270V	AC 95V-280V		
OUTPUT VOITAGE	AC 220V±10% 50/60Hz			
DELAY TIME	Short Delay:3-5sec Long Deley:3-7min			
PROTECTION	Over Voltage(246V±4V),Overload,High Temperature,Short Circuit			
POWER	8000VA	10000VA	15000VA	20000VA
PRODUCT SIZE(CM)	46.2x26.6x33.4	46.2x26.6x33.4	46.2x26.6x33.4	46.2x26.6x33.4
PACKING SIZE(CM)	50.5x32.5x39	50.5x32.5x39	50.5x32.5x39	50.5x32.5x39
PCS/CARTON	1	1	1	1
N.W.(KG)	20	23.3	26.6	29.9
G.W.(KG)	21.3	24.6	27.9	31.5

LED Display



Air Circulation



### TECHNICAL DRAWING

Metal panel

LED-3B

Screen sticker

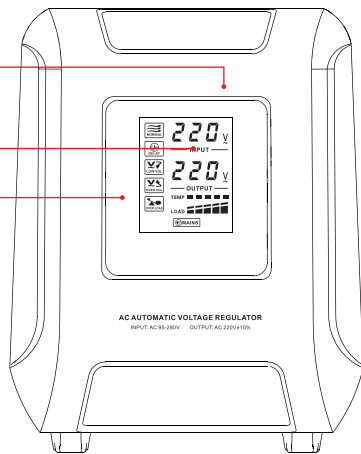

USB assembly

Delay button

Fan

Air switch

Universal socket

Grounding terminal

Input/output terminal

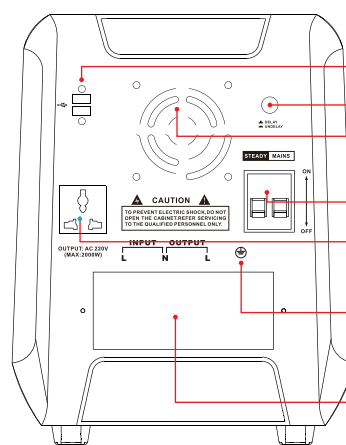

Widely used in various industries, small office equipment, refrigerator, electric fan, computer, pump, air conditioner, etc.



Washing Maching LCD TV Rice Cooker Microwave Oven Printer Computer

Relay Control + Toroidal Transformer, Efficiency > 97%

# ARS-SAB/SAB95 Series (500VA-2000VA)



ISO9001



The product of this model is a 220V fully automatic small-sized voltage regulator, which is a portable LED digital display design. It is characterized by relay switching gear, high voltage regulation speed and wide range.

## TECHNICAL DATA

MODEL	ARS-SAB(500VA-2000VA)	ARS-SAB95(500VA-2000VA)		
INPUT VOLTAGE	AC 130V-270V	AC 95V-270V		
OUTPUT VOITAGE	AC 220V±10% 50/60Hz			
DELAY TIME	Short Delay:3-5sec Long Delay:3-7min			
PROTECTION	Over Voltage(246V±4V),Overload,High Temperature,Short Circuit			
POWER	500VA	1000VA	1500VA	2000VA
PRODUCT SIZE(CM)	30x15.5x20	30x15.5x20	30x15.5x20	30x15.5x20
PACKING SIZE(CM)	39.5x35x50	39.5x35x50	39.5x35x50	39.5x35x50
PCS/CARTON	4	4	4	4
N.W.(KG)	10.3	13.6	18.9	20.2
G.W.(KG)	12.3	15.8	20.5	24



LED Display



Power Button



## TECHNICAL DRAWING

Screen sticker

Plastic panel

LCD-6B

Indicator light board

Delay button

Switch

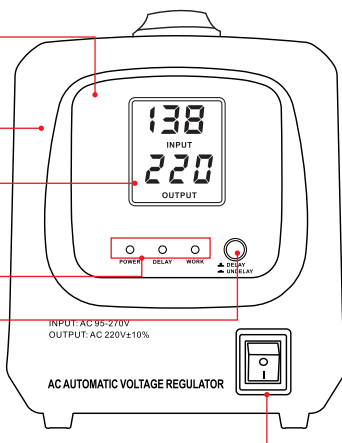

Handle

CAUTION  
TO PREVENT ELECTRIC SHOCK, DO NOT OPEN THE CABINET. REFER SERVICING TO QUALIFIED PERSONNEL ONLY.

INPUT: 95-270V AC 50Hz  
OUTPUT: 220V AC 50Hz  
STABILITY:±10%

Five-hole universal socket

Fuse socket

Power cord

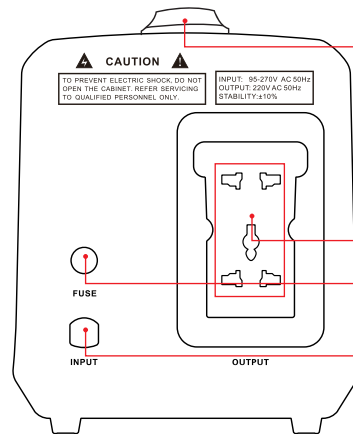

Widely used in various industries, small office equipment, refrigerator, electric fan, computer, pump, air conditioner, etc.



Washing Maching Fridge Air Conditioner Air compressor Motor Water pump

Relay Control + Toroidal Transformer, Efficiency > 97%

# ARS-TMJ/TMJ95 Series (500VA-2000VA)

ISO9001



Black

Camel



The product of this model is a 220V fully automatic small-sized voltage regulator, which is a portable LED digital display design. It is characterized by relay switching gear, high voltage regulation speed and wide range.

## TECHNICAL DATA

MODEL	TMJ(500VA-2000VA)	TMJ95(500VA-2000VA)		
INPUT VOLTAGE	AC 130V-270V	AC 95V-270V		
OUTPUT VOLTAGE	AC 220V±10% 50/60Hz			
DELAY TIME	Short Delay:3-5secA			
PROTECTION	Over Voltage(246V±4V),Overload,High Temperature,Short Circuit			
POWER	500VA	1000VA	1500VA	2000VA
PRODUCT SIZE(CM)	28x16.2x9.5	28x16.2x9.5	28x16.2x9.5	32.4x18.2x10.4
PACKING SIZE(CM)	63.5x36x30	63.5x36x30	63.5x36x30	70x38.5x32.5
PCS/CARTON	6	6	6	6
N.W.(KG)	15.2	19.7	26.6	31.8
G.W.(KG)	17.6	21.8	29	35.3

## TECHNICAL DRAWING

Plastic panel

Screen sticker

LCD-6B

Indicator light board

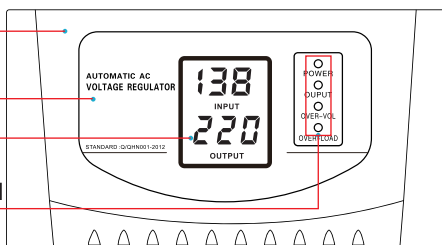

Mcb over current protector

Kcd2 switch

Fan

Universal socket

Power cord

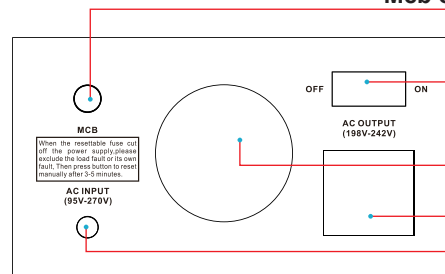

Widely used in various industries, small office equipment, refrigerator, electric fan, computer, pump, air conditioner, etc.



Washing Maching LCD TV Rice Cooker Microwave Oven Printer Computer

Relay Control + Toroidal Transformer, Efficiency > 97%

# ARS-SVB/SVB95 Series (1000VA-2000VA)



ISO9001



The product of this model is a 220V fully automatic small-sized voltage regulator, retro style and portable LCD display design. It is characterized by small size, light weight and high pressure regulation speed.

## TECHNICAL DATA

MODEL	ARS-SVB(1000VA-2000VA)	ARS-SVB95(1000VA-2000VA)
INPUT VOLTAGE	AC 130V-270V	AC 95V-270V
OUTPUT VOITAGE	AC 220V±10% 50/60Hz	
DELAY TIME	Short Delay:3-5sec Long Delay:3-7min	
PROTECTION	Over Voltage(246V±4V),Overload,High Temperature,Short Circuit	
POWER	1000VA	1500VA 2000VA
PRODUCT SIZE(CM)	28.5x15x19	28.5x15x19 28.5x15x19
PACKING SIZE(CM)	60x33x45	60x33x45 60x33x45
PCS/CARTON	6	6 6
N.W.(KG)	22.4	29.4 32
G.W.(KG)	25.3	32.3 34.9

Black



Camel



## TECHNICAL DRAWING

Plastic panel

LCD-6B

Indicator light board

Delay button

Switch

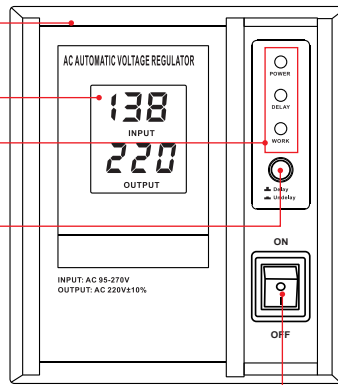

CAUTION  
TO PREVENT ELECTRIC SHOCK, DO NOT OPEN THE CABINET. REFER SERVICING TO QUALIFIED PERSONNEL ONLY.

Five-hole universal socket

Fuse socket

Power cord

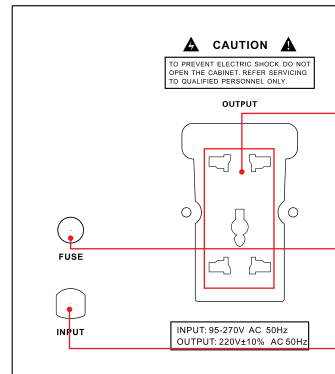

Widely used in various industries, small office equipment, refrigerator, electric fan, computer, pump, air conditioner, etc.



Washing Maching LCD TV Rice Cooker Microwave Oven Printer Computer

Relay Control + Toroidal Transformer, Efficiency > 97%

# ARS-SVB/SVB95 Series (3000VA-5000VA)



ISO9001



The product of this model is a 220V fully automatic voltage regulator, with LCD display design. It is characterized by stable work, high pressure regulation speed and wide voltage regulation range.

## TECHNICAL DATA

MODEL	ARS-SVB(3000VA-5000VA)	ARS-SVB95(3000VA-5000VA)
INPUT VOLTAGE	AC 130V-270V	AC 95V-270V
OUTPUT VOITAGE	AC 220V±10% 50/60Hz	
DELAY TIME	Short Delay:3-5sec Long Delay:3-7min	
PROTECTION	Over Voltage(246V±4V), Overload, High Temperature, Short Circuit	
POWER	3000VA	5000VA
PRODUCT SIZE(CM)	38.5x21.5x25.5	38.5x21.5x25.5
PACKING SIZE(CM)	42.5x26.5x29	42.5x26.5x29
PCS/CARTON	1	1
N.W.(KG)	10.2	11.4
G.W.(KG)	11	12.2

Black



Camel



## TECHNICAL DRAWING

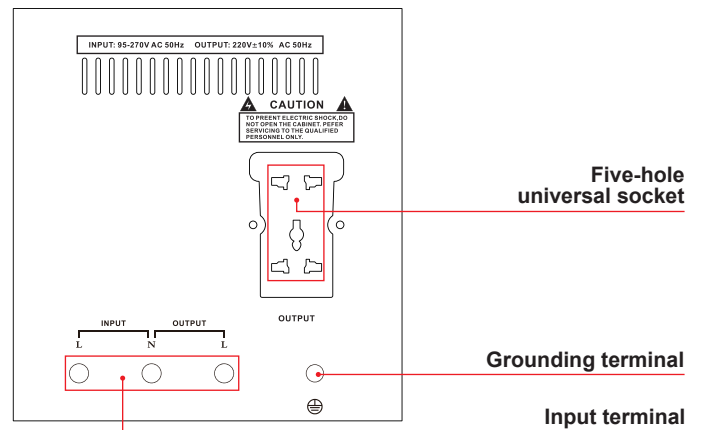
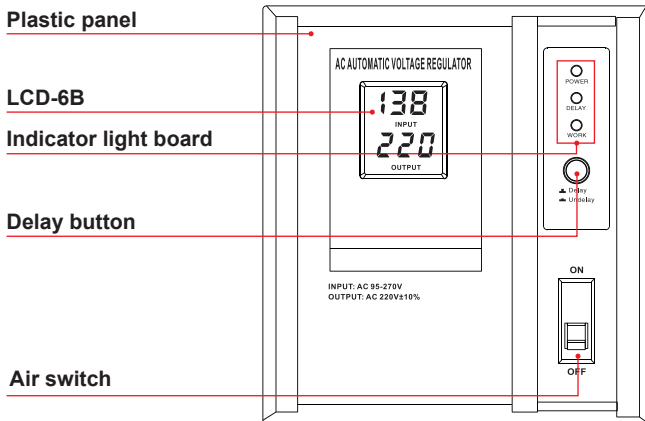

Widely used in various industries, small office equipment, refrigerator, electric fan, computer, pump, air conditioner, etc.



Washing Maching LCD TV Rice Cooker Microwave Oven Printer Computer

Relay Control + Toroidal Transformer, Efficiency > 97%

# ARS-SVE/SVE95 Series (1000VA-2000VA)



ISO9001



The product of this model is a 220V fully automatic small-sized voltage regulator, with portable LED display design. It is characterized by small size, light weight and high pressure regulation speed.

## TECHNICAL DATA

MODEL	ARS-SVE(1000VA-2000VA)	ARS-SVE95(1000VA-2000VA)
INPUT VOLTAGE	AC 130V-270V	AC 95V-270V
OUTPUT VOITAGE	AC 220V±10% 50/60Hz	
DELAY TIME	Short Delay:3-5sec Long Delay:3-7min	
PROTECTION	Over Voltage(246V±4V),Overload,High Temperature,Short Circuit	
POWER	1000VA	1500VA 2000VA
PRODUCT SIZE(CM)	28.5x15x19	28.5x15x19 28.5x15x19
PACKING SIZE(CM)	60x33x45	60x33x45 60x33x45
PCS/CARTON	6	6 6
N.W.(KG)	22.4	29.4 32
G.W.(KG)	25.3	32.3 34.9

Black



Camel



## TECHNICAL DRAWING

Plastic panel

LED-1B

Indicator light board

Delay button

Switch

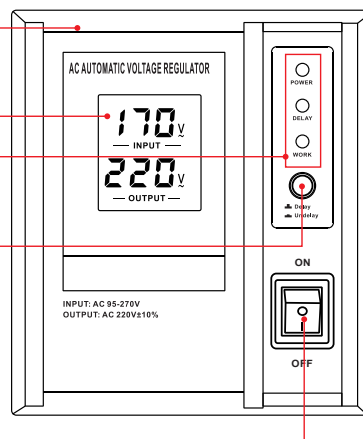

**CAUTION**  
TO PREVENT ELECTRIC SHOCK, DO NOT OPEN THE CABINET. REFER SERVICING TO QUALIFIED PERSONNEL ONLY.

Five-hole universal socket

Fuse socket

Power cord

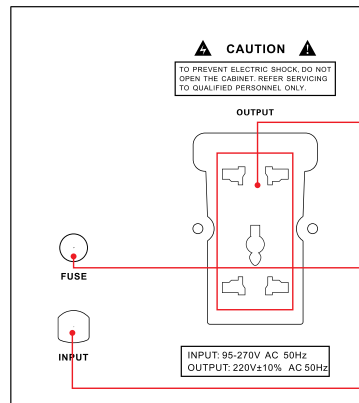

Widely used in various industries, small office equipment, refrigerator, electric fan, computer, pump, air conditioner, etc.



Washing Maching LCD TV Rice Cooker Microwave Oven Printer Computer

Relay Control + Toroidal Transformer, Efficiency > 97%

# ARS-SVE/SVE95 Series (3000VA-5000VA)



ISO9001



The product of this model is a 220V fully automatic voltage regulator, with LED display design. It is characterized by stable work, high pressure regulation speed and wide voltage regulation range.

## TECHNICAL DATA

MODEL	ARS-SVE(3000VA-5000VA)	ARS-SVE95(3000VA-5000VA)
INPUT VOLTAGE	AC 130V-270V	AC 95V-270V
OUTPUT VOLTAGE	AC 220V±10% 50/60Hz	
DELAY TIME	Short Delay:3-5sec Long Delay:3-7min	
PROTECTION	Over Voltage(246V±4V), Overload, High Temperature, Short Circuit	
POWER	3000VA	5000VA
PRODUCT SIZE(CM)	38.5x21.5x25.3	38.5x21.5x25.3
PACKING SIZE(CM)	42.5x26.5x29	42.5x26.5x29
PCS/CARTON	1	1
N.W.(KG)	9.5	12.8
G.W.(KG)	10.3	13.6

Black



Camel



## TECHNICAL DRAWING

- Plastic panel
- LED-1B
- Indicator light board
- Delay button
- Air switch

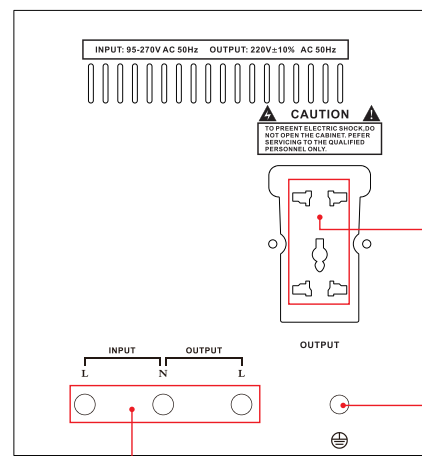
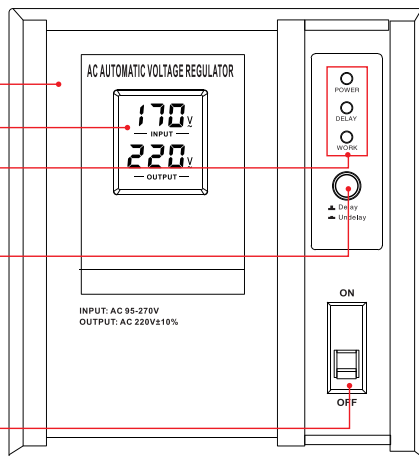

Widely used in various industries, small office equipment, refrigerator, electric fan, computer, pump, air conditioner, etc.



Washing Maching LCD TV Rice Cooker Microwave Oven Printer Computer

Relay Control + Toroidal Transformer, Efficiency > 97%



# ARS-SVR/SVR95 Series (500VA-2000VA)



ISO9001

NORMAL

DELAY

LOW VOL

OVER VOL

OVER LOAD

The product of this model is a 220V fully automatic small-sized voltage regulator, retro style and portable pointer display design. It is characterized by small size, light weight and high pressure regulation speed.

### TECHNICAL DATA

MODEL	ARS-SVR(500VA-2000VA)	ARS-SVR95(500VA-2000VA)		
INPUT VOLTAGE	AC 130V-270V	AC 95V-270V		
OUTPUT VOITAGE	AC 220V±10% 50/60Hz			
DELAY TIME	Short Delay:3-5sec Long Delay:3-7min			
PROTECTION	Over Voltage(246V±4V), Overload, High Temperature, Short Circuit			
POWER	500VA	1000VA	1500VA	2000VA
PRODUCT SIZE(CM)	25.5x11x16	28.5x15x18.9	28.5x15x18.9	28.5x15x18.9
PACKING SIZE(CM)	63.2x31.5x39	60x33x45	60x33x45	60x33x45
PCS/CARTON	8	6	6	6
N.W.(KG)	20	22.4	29.4	32
G.W.(KG)	22.8	25.3	32.3	34.9

Black



Camel



### TECHNICAL DRAWING

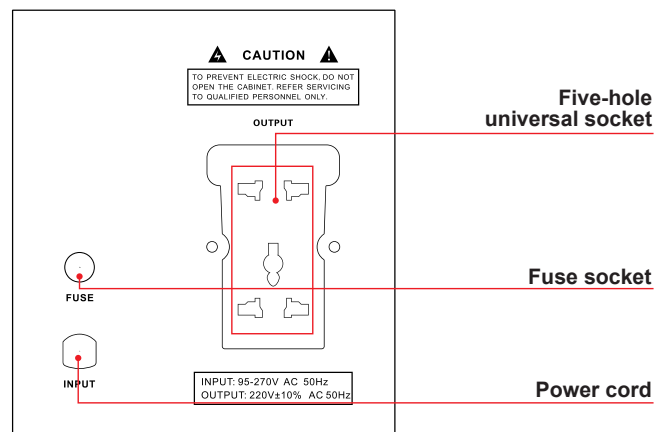
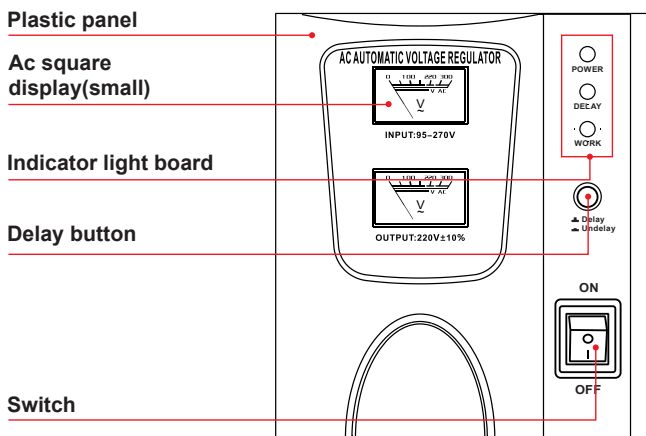

Widely used in various industries, small office equipment, refrigerator, electric fan, computer, pump, air conditioner, etc.



Washing Maching LCD TV Rice Cooker Microwave Oven Printer Computer

Relay Control + Toroidal Transformer, Efficiency > 97%

# ARS-SVR/SVR95 Series (3000VA-5000VA)



ISO9001



The product of this model is a 220V fully automatic voltage regulator, retro style and pointer display design. It is characterized by stable work, high pressure regulation speed and wide voltage regulation range.

## TECHNICAL DATA

MODEL	ARS-SVR(3000VA-5000VA)	ARS-SVR95(3000VA-5000VA)
INPUT VOLTAGE	AC 130V-270V	AC 95V-270V
OUTPUT VOITAGE	AC 220V±10% 50/60Hz	
DELAY TIME	Short Delay:3-5sec Long Delay:3-7min	
PROTECTION	Over Voltage(246V±4V),Overload,High Temperature,Short Circuit	
POWER	3000VA	5000VA
PRODUCT SIZE(CM)	38.5x21.5x25.5	38.5x21.5x25.5
PACKING SIZE(CM)	42.5x26.5x29	42.5x26.5x29
PCS/CARTON	1	1
N.W.(KG)	10.2	11.6
G.W.(KG)	11	12.2

Black



Camel



## TECHNICAL DRAWING

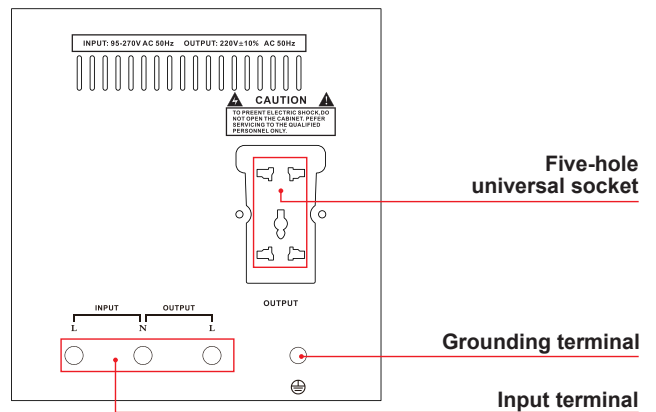
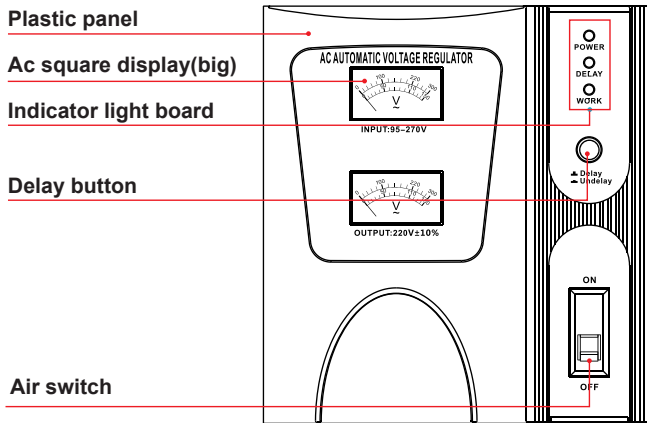

Widely used in various industries, small office equipment, refrigerator, electric fan, computer, pump, air conditioner, etc.



Washing Maching LCD TV Rice Cooker Microwave Oven Printer Computer

Relay Control + Toroidal Transformer, Efficiency > 97%

# ARS-SVF/SVF95 Series (3000VA-5000VA)



ISO9001



The product of this model is a 220V fully automatic voltage regulator, which is a portable LED digital display design. With self-protection function. It is characterized by stable work, high voltage regulation speed, no waveform distortion and strong instant overload ability.

## TECHNICAL DATA

MODEL	ARS-SVF(3000VA-5000VA)	ARS-SVF95(3000VA-5000VA)
INPUT VOLTAGE	AC 130V-270V	AC 95V-270V
OUTPUT VOITAGE	AC 220V±10% 50/60Hz	
DELAY TIME	Short Delay:3-5sec Long Deley:3-7min	
PROTECTION	Over Voltage(246V±4V),Overload,High Temperature,Short Circuit	
POWER	3000VA	5000VA
PRODUCT SIZE(CM)	38.5x21.5x25.5	38.5x21.5x25.5
PACKING SIZE(CM)	42.5x26.5x29	42.5x26.5x29
PCS/CARTON	1	1
N.W.(KG)	10.2	11.6
G.W.(KG)	11	12.3

Black



Pink



## TECHNICAL DRAWING

Screen cover

Plastic panel

LED-1B

Indicator light board

Delay button

Air switch

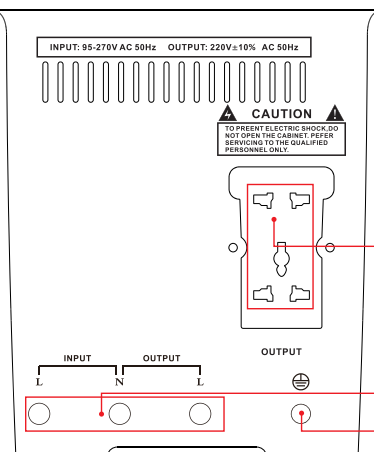
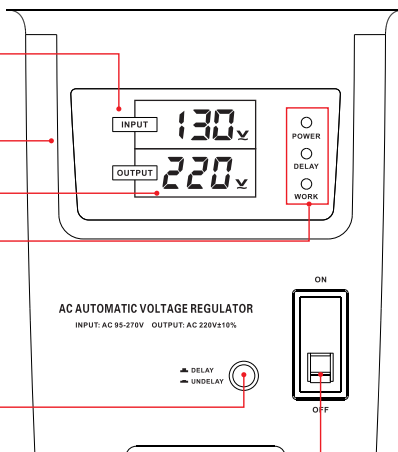

Five-hole universal socket

Input terminal

Grounding terminal

Widely used in various industries, small office equipment, refrigerator, electric fan, computer, pump, air conditioner, etc.



Washing Maching    LCD TV    Rice Cooker    Microwave Oven    Printer    Computer

Relay Control + Toroidal Transformer, Efficiency > 97%

# ARS-TML/TML95 Series (500VA-2000VA)



ISO9001



The product of this model is a 220V fully automatic small-sized voltage regulator, with concise and generous appearance. Display of LED digital design. It is characterized by small size, light weight and high pressure regulation speed.

## TECHNICAL DATA

MODEL	ARS-TML(500VA-2000VA)	ARS-TML95(500VA-2000VA)		
INPUT VOLTAGE	AC 130V-270V	AC 95V-270V		
OUTPUT VOLTAGE	AC 220V±10% 50/60Hz			
DELAY TIME	Short Delay:3-5sec Long Delay:3-7min			
PROTECTION	Over Voltage(246V±4V), Overload, High Temperature, Short Circuit			
POWER	500VA	1000VA	1500VA	2000VA
PRODUCT SIZE(CM)	25.5x11x16	28.5x15x19	28.5x15x19	28.5x15x19
PACKING SIZE(CM)	63.2x31.5x39	60x33x45	60x33x45	60x33x45
PCS/CARTON	8	6	6	6
N.W.(KG)	21.9	23.6	30.2	33.7
G.W.(KG)	22	26.2	33	35.8

LED Display



Power Button



## TECHNICAL DRAWING

Metal panel

LED-1B

Screen cover

Delay button

Switch

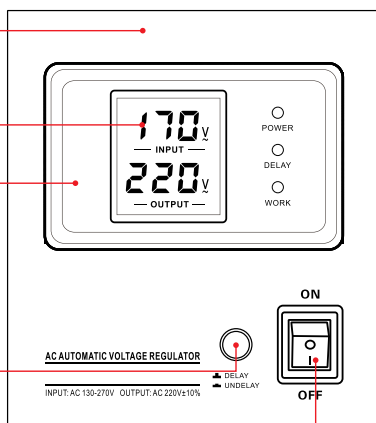

CAUTION  
TO PREVENT ELECTRIC SHOCK, DO NOT OPEN THE CABINET. REFER SERVICING TO QUALIFIED PERSONNEL ONLY.

OUTPUT

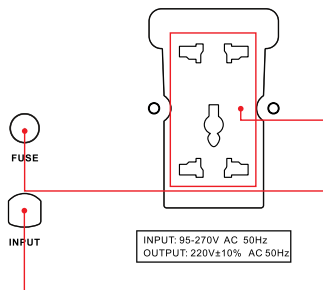

Five-hole universal socket

Fuse socket

Power cord

Widely used in various industries, small office equipment, refrigerator, electric fan, computer, pump, air conditioner, etc.



Washing Maching LCD TV Rice Cooker Microwave Oven Printer Computer

Relay Control + Toroidal Transformer, Efficiency > 97%

# ARS-TML/TML95

Series (3000VA-10KVA)



ISO9001



The product of this model is a 220V fully automatic voltage regulator, design of imitating computer case, with concise and generous appearance. Display of LED digital design. It is characterized by stable work, high pressure regulation speed and wide voltage regulation range.

## TECHNICAL DATA

MODEL	ARS-TML(3000VA-10KVA)	ARS-TML95(3000VA-10KVA)		
INPUT VOLTAGE	AC 130V-270V	AC 95V-270V / AC 95V-280V		
OUTPUT VOLTAGE	AC 220V±10% 50/60Hz			
DELAY TIME	Short Delay:3-5sec Long Delay:3-7min			
PROTECTION	Over Voltage(246V±4V), Overload, High Temperature, Short Circuit			
POWER	3000VA	5000VA	8000VA	10000VA
PRODUCT SIZE(CM)	30x23x21.5	34.5x22.5x27.3	41.5x24x36	41.5x24x36
PACKING SIZE(CM)	35.5x28.5x27.5	40x28x34	47x30x42.5	47x30x42.5
PCS/CARTON	2	1	1	1
N.W.(KG)	10.1	14.4	23.6	26
G.W.(KG)	10.7	15.5	24.6	27

LED Display



Switch Button



## TECHNICAL DRAWING

Metal panel

LED-2B

Screen sticker

Air switch

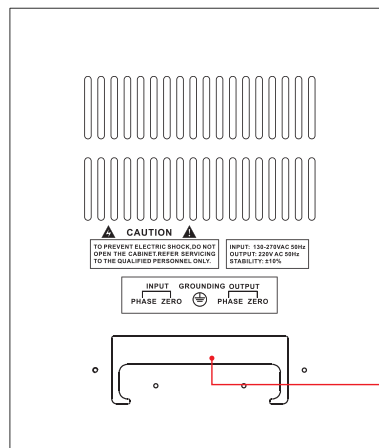
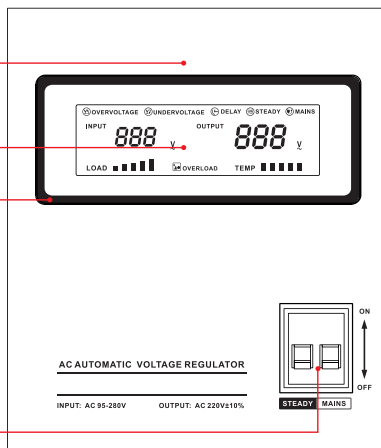

Terminal block

Widely used in various industries, small office equipment, refrigerator, electric fan, computer, pump, air conditioner, etc.



Washing Maching Fridge Air Conditioner Air compressor Motor Water pump

Relay Control + Toroidal Transformer, Efficiency > 97%

# ARS-TMG/TMG95 Series (15KVA-20KVA)



ISO9001



The product of this model is a 220V fully automatic voltage regulator, design of LCD digital display and easy move. It is characterized by stable work, high pressure regulation speed and wide voltage regulation range.

## TECHNICAL DATA

MODEL	ARS-TMG(15KVA/20KVA)	ARS-TMG95(15KVA/20KVA)
INPUT VOLTAGE	AC 130V-270V	AC 95V-280V
OUTPUT VOITAGE	AC 220V±10% 50/60Hz	
DELAY TIME	Short Delay:3-5sec	
PROTECTION	Over Voltage(246V±4V),Overload,High Temperature,Short Circuit	
POWER	15000VA	20000VA
PRODUCT SIZE(CM)	34.5x31.5x57.5	34.5x31.5x57.5
PACKING SIZE(CM)	40x37x66.5	40x37x66.5
PCS/CARTON	1	1
N.W.(KG)	30.5	33.5
G.W.(KG)	36.8	39.7

LED Display



Switch Button



## TECHNICAL DRAWING

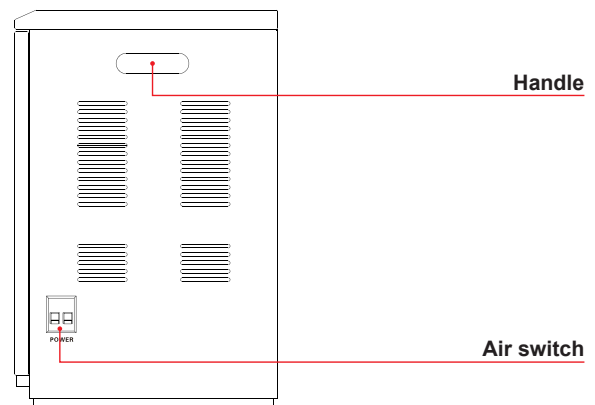
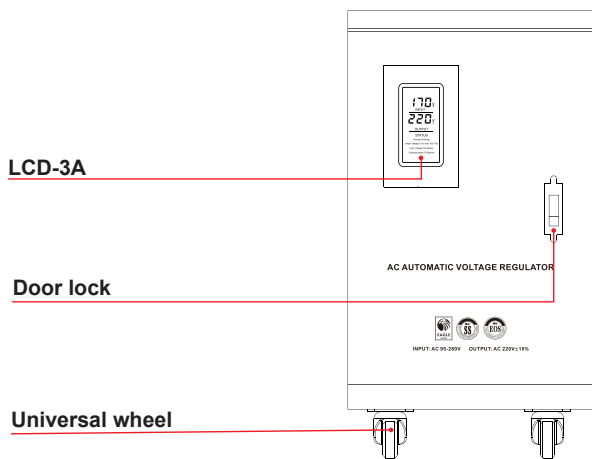

Widely used in various industries, small office equipment, refrigerator, electric fan, computer, pump, air conditioner, etc.



Washing Maching LCD TV Rice Cooker Microwave Oven Printer Computer

Relay Control + Toroidal Transformer, Efficiency > 97%

# ARS-TMG-A/95

Series (15KVA-20KVA)

ISO9001



The product of this model is a 220V fully automatic voltage regulator, design of LCD digital display and easy move. It is characterized by stable work, high pressure regulation speed and wide voltage regulation range.

### TECHNICAL DATA

MODEL	ARS-TMG-A(15KVA/20KVA)	ARS-TMG-A95(15KVA/20KVA)
INPUT VOLTAGE	AC 130V-270V	AC 95V-280V
OUTPUT VOITAGE	AC 220V±10% 50/60Hz	
DELAY TIME	Short Delay:3-5sec	
PROTECTION	Over Voltage(246V±4V),Overload,High Temperature,Short Circuit	
POWER	15000VA	20000VA
PRODUCT SIZE(CM)	34.5x31.5x57.5	34.5x31.5x57.5
PACKING SIZE(CM)	40x37x66.5	40x37x66.5
PCS/CARTON	1	1
N.W.(KG)	30.5	33.5
G.W.(KG)	36.8	39.7



LED Display



Switch Button



### TECHNICAL DRAWING

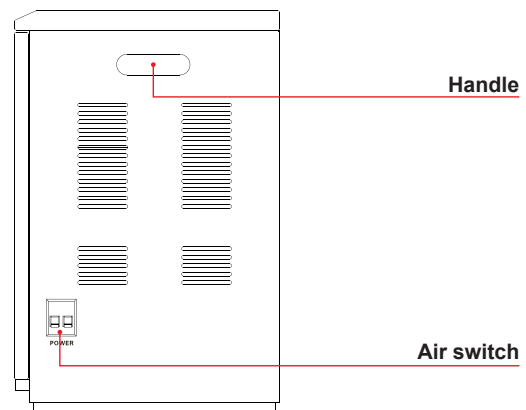
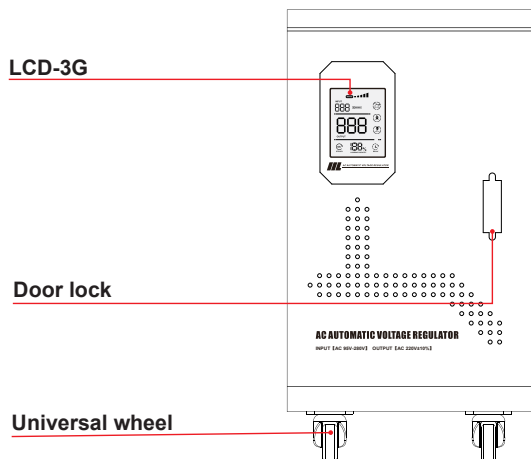

Widely used in various industries, small office equipment, refrigerator, electric fan, computer, pump, air conditioner, etc.



Washing Maching Fridge Air Conditioner Air compressor Motor Water pump

Relay Control + Toroidal Transformer, Efficiency > 97%

# ARS-TMH 45/60/95 Series (3000VA-10KVA)

ISO9001



The product of this model is a 220V fully automatic voltage regulator, design of LED digital display, southeast Asian style and appearance. It is characterized by stable work, high pressure regulation speed and wide voltage regulation range.

### TECHNICAL DATA

MODEL	ARS-TMH45 (3000VA-10KVA)	ARS-TMH60 (3000VA-10KVA)	ARS-TMH95 (3000VA-10KVA)
INPUT VOLTAGE	AC 45V-280V	AC 60V-280V	AC 95V-280V
OUTPUT VOITAGE	AC 220V±10% 50/60Hz		
DELAY TIME	Short Delay:3-5sec		
PROTECTION	Over Voltage(246V±4V),Overload,High Temperature,Short Circuit		
POWER	3000VA	5000VA	10KVA
PRODUCT SIZE(CM)	39x26x35	39x26x35	39x26x35
PACKING SIZE(CM)	45x31.5x43.5	45x31.5x43.5	45x31.5x43.5
PCS/CARTON	1	1	1
N.W.(KG)	15	16.2	24.5
G.W.(KG)	20.3	22	30.7



LED Display



Switch Button



### TECHNICAL DRAWING

LED-2B

Screen sticker

Universal socket

Metal panel

Air switch

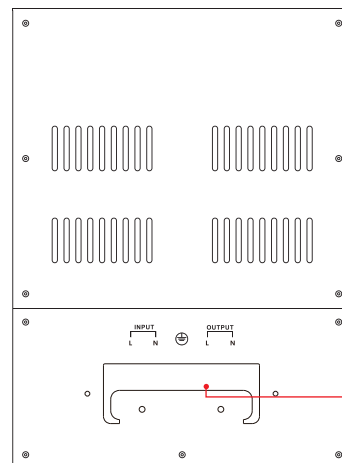
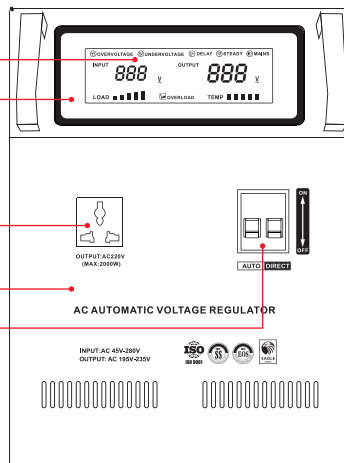

Terminal block

Widely used in various industries, small office equipment, refrigerator, electric fan, computer, pump, air conditioner, etc.



Washing Maching Fridge Air Conditioner Air compressor Motor Water pump

Relay Control + Toroidal Transformer, Efficiency > 97%



# ARS-TMH 45/60/95

Series (15KVA-20KVA)

ISO9001



The product of this model is a 220V fully automatic voltage regulator, design of LED digital display, southeast Asian style and appearance. It is characterized by stable work, high pressure regulation speed and wide voltage regulation range.



### TECHNICAL DATA

MODEL	ARS-TMH45 (15KVA-20KVA)	ARS-TMH60 (15KVA-20KVA)	ARS-TMH95 (15KVA-20KVA)
INPUT VOLTAGE	AC 45V-280V	AC 60V-280V	AC 95V-280V
OUTPUT VOITAGE	AC 220V±10% 50/60Hz		
DELAY TIME	Short Delay:3-5sec		
PROTECTION	Over Voltage(246V±4V),Overload,High Temperature,Short Circuit		
POWER	15000VA	20000VA	
PRODUCT SIZE(CM)	39x35x35	39x35x35	
PACKING SIZE(CM)	45.5x41.5x44	45.5x41.5x44	
PCS/CARTON	1	1	
N.W.(KG)	28	31.8	
G.W.(KG)	34.2	37.7	

LED Display



Switch Button



### TECHNICAL DRAWING

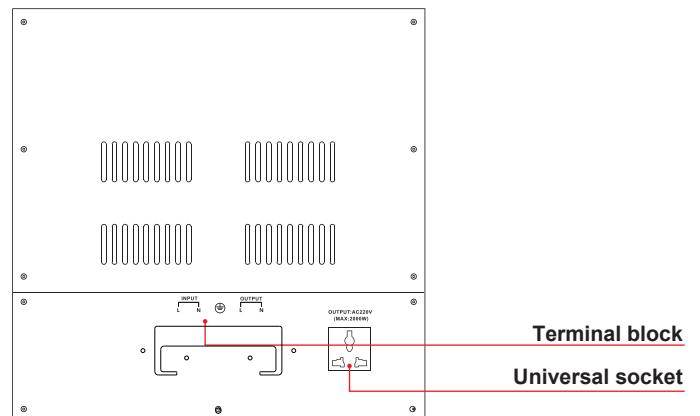
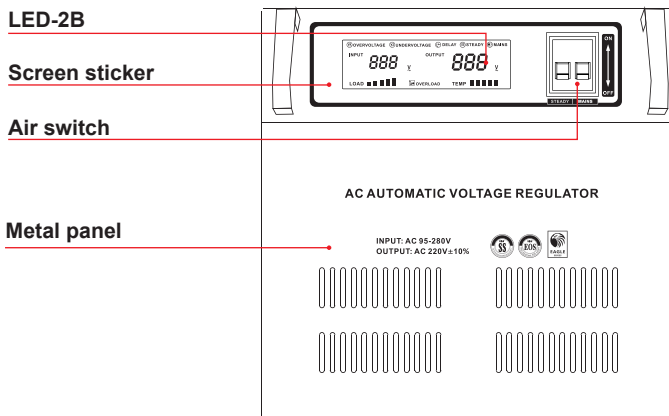

Widely used in various industries, small office equipment, refrigerator, electric fan, computer, pump, air conditioner, etc.



Washing Maching Fridge Air Conditioner Air compressor Motor Water pump

Relay Control + Toroidal Transformer, Efficiency > 97%

# ARS-TMH 45/60/95 Series (30KVA)



ISO9001



The product of this model is a 220V fully automatic voltage regulator, design of LED digital display, southeast Asian style and appearance. It is characterized by stable work, high pressure regulation speed and wide voltage regulation range.

### TECHNICAL DATA

MODEL	ARS-TMH45-30KVA	ARS-TMH60-30KVA	ARS-TMH95-30KVA
INPUT VOLTAGE	AC 45V-280V	AC 60V-280V	AC 95V-280V
OUTPUT VOLTAGE	AC 220V±10% 50/60Hz		
DELAY TIME	Short Delay:3-5sec		
PROTECTION	Over Voltage(246V±4V), Overload, High Temperature, Short Circuit		
POWER	30000VA		
PRODUCT SIZE(CM)	45x41.5x52.2		
PACKING SIZE(CM)	51.5x46.5x67		
PCS/CARTON	1		
N.W.(KG)	50		
G.W.(KG)	60.2		

LED Display



Switch Button



### TECHNICAL DRAWING

Screen sticker

LED-2B

Air switch

Metal panel

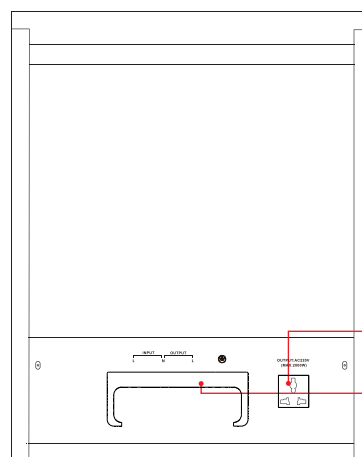
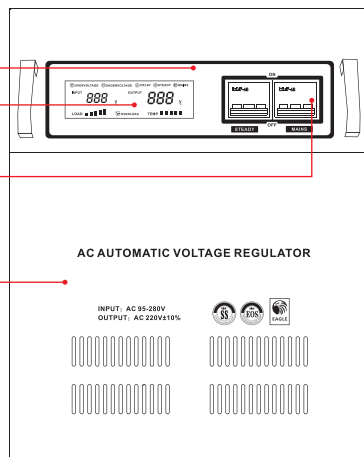

Universal socket

Terminal block

Widely used in various industries, small office equipment, refrigerator, electric fan, computer, pump, air conditioner, etc.



Washing Maching Fridge Air Conditioner Air compressor Motor Water pump

Relay Control + Toroidal Transformer, Efficiency > 97%

**ARAKAWA STABILIZER**  
 Digital Display



# SERVO TYPE

Servo-type stabilizers generally offer faster response times & more precise voltage regulation compared to relay-type stabilizers. Suitable for applications where a high level of voltage stability is crucial, such as in sensitive electronic & industrial equipment.

ISO9001

NORMAL DELAY LOW VOL OVER VOL OVER LOAD

# ARS-SVC-PC

Series

(5000VA-10KVA)



ISO9001



The product of this model is a high-precision regulator, both for desktop and wall mounted, with LED digital display design, using motor-driven carbon brush sliding between turns of self-coupling transformer winding and directly adjust the output voltage, two kinds of output voltage 110V/220V.

## TECHNICAL DATA

MODEL	ARS-SVC-PC-5KVA	ARS-SVC-PC-10KVA
INPUT VOLTAGE	AC 100V-260V / 130V-250V	
OUTPUT VOITAGE	AC 220V±1~3% 50/60Hz	
DELAY TIME	Short Delay:3-5sec Long Deley:3-7min	
PROTECTION	Over Voltage(246V±4V),Overload,High Temperature,Short Circuit	
POWER	5000VA	10000VA
PRODUCT SIZE(CM)	39.5x26.5x17	45x31.5x18.5
PACKING SIZE(CM)	45.5x32.5x23.5	51x37.5x25
PCS/CARTON	1	1
N.W.(KGS)	17.5	24.1
G.W.(KGS)	18.5	25.3

LED Display



Socket Hole



## TECHNICAL DRAWING

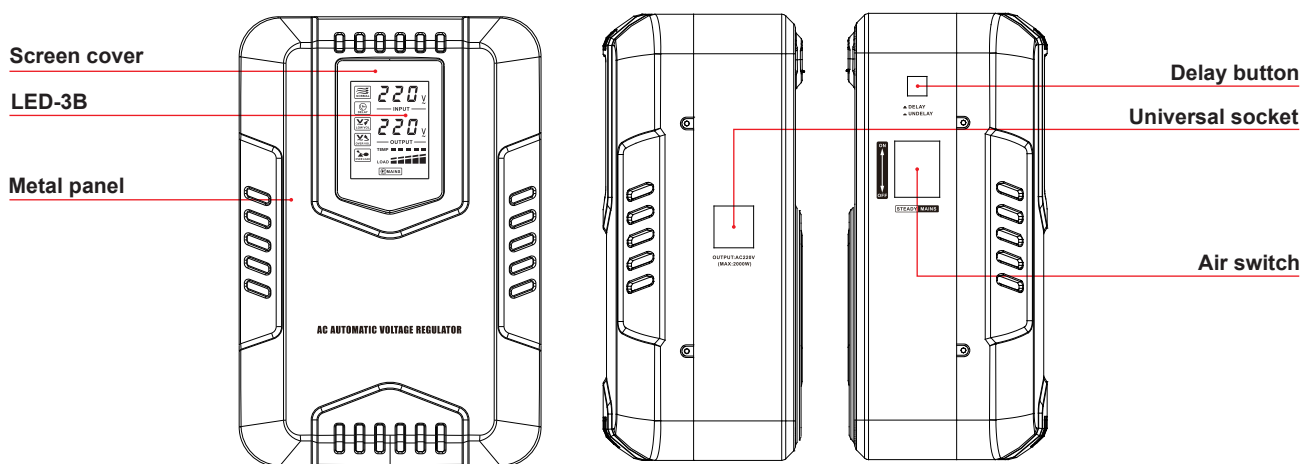

Widely used in various industries, small office equipment, refrigerator, electric fan, computer, pump, air conditioner, etc.



Washing Maching Fridge Air Conditioner Air compressor Motor Water pump

Servo Control + Toroidal Transformer, Efficiency > 97%

# ARS-TVC

Series

(500VA-2000VA)



ISO9001



The product of this model is a high-precision regulator, both for desktop and wall mounted, with LED digital display design, using motor-driven carbon brush sliding between turns of self-coupling transformer winding and directly adjust the output voltage, two kinds of output voltage 110V/220V.

## TECHNICAL DATA

MODEL	ARS-TVC(500VA-2000VA)			
INPUT VOLTAGE	AC 100V-260V / 130V-250V			
OUTPUT VOITAGE	AC 220V±1~3% 50/60Hz			
DELAY TIME	Short Delay:3-5sec Long Deley:3-7min			
PROTECTION	Over Voltage(246V±4V),Overload,High Temperature,Short Circuit			
POWER	500VA	1000VA	1500VA	2000VA
PRODUCT SIZE(CM)	22.8x14.2x12.1	25.3x15.2x13.6	25.3x15.2x13.6	27.3x17.7x14.6
PACKING SIZE(CM)	31x30.5x32.5	33x33x35.5	33x33x35.5	38x35x37.5
PCS/CARTON	4	4	4	4
N.W.(KGS)	16.8	23.2	27.2	29.6
G.W.(KGS)	18	24.5	28.5	31

LED Display



Air Circulation

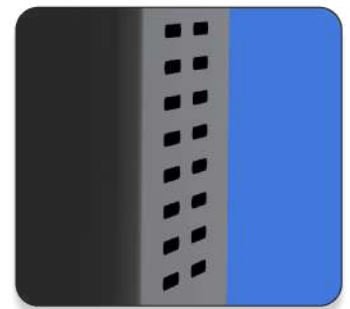

Metal panel

Screen cover

LED-3G

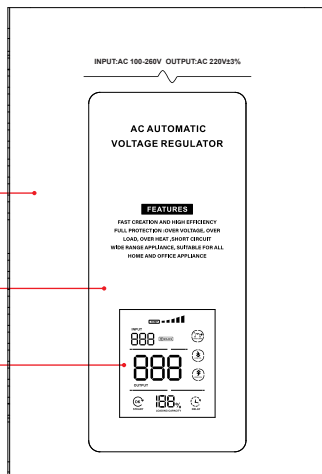

## TECHNICAL DRAWING

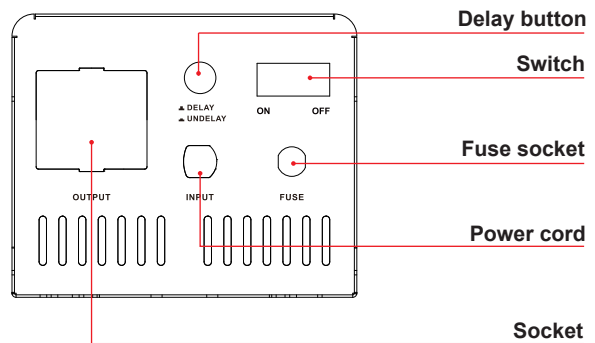

Widely used in various industries, small office equipment, refrigerator, electric fan, computer, pump, air conditioner, etc.



Washing Maching Fridge Air Conditioner Air compressor Motor Water pump

Servo Control + Toroidal Transformer, Efficiency > 97%

# ARS-TVC

Series

(3000VA-5000VA)



ISO9001



The product of this model is a **220V** fully automatic voltage regulator, both for desktop & wall mounted. With LED digital display design. It is characterized by stable work, high pressure regulation speed and wide voltage regulation range.

## TECHNICAL DATA

MODEL	ARS-TVC-3000VA
INPUT VOLTAGE	AC 100V-260V / 130V-250V
OUTPUT VOITAGE	AC 220V±1~3% 50/60Hz
DELAY TIME	Short Delay:3-5sec Long Deley:3-7min
PROTECTION	Over Voltage(246V±4V),Overload,High Temperature,Short Circuit
POWER	3000VA
PRODUCT SIZE(CM)	34.1x21.2x14.6
PACKING SIZE(CM)	39x26x20
PCS/CARTON	1
N.W.(KGS)	11.3
G.W.(KGS)	11.7

LED Display



Air Circulation

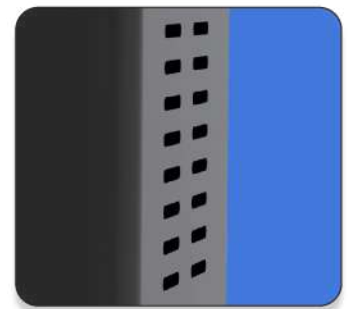

## TECHNICAL DATA

MODEL	ARS-TVC-5000VA
INPUT VOLTAGE	AC 100V-260V / 130V-250V
OUTPUT VOLTAGE	AC 220V±1~3% 50/60Hz
DELAY TIME	Short Delay:3-5sec Long Deley:3-7min
PROTECTION	Over Voltage(246V±4V),Overload,High Temperature,Short Circuit
POWER	5000VA
PRODUCT SIZE(CM)	37.3x24.2x16.6
PACKING SIZE(CM)	42.3x29x22
PCS/CARTON	1
N.W.(KGS)	16.9
G.W.(KGS)	17.4

Widely used in various industries, small office equipment, refrigerator, electric fan, computer, pump, air conditioner, etc.



Washing Maching Fridge Air Conditioner Air compressor Motor Water pump

Servo Motor Control + Toroidal Transformer, Efficiency > 97%

# ARS-TVC

Series

(10KVA-15KVA)



ISO9001



The product of this model is a **220V** fully automatic voltage regulator, both for desktop & wall mounted. With LED digital display design. It is characterized by stable work, high pressure regulation speed and wide voltage regulation range.

## TECHNICAL DATA

MODEL	ARS-TVC(10KVA-15KVA)	
INPUT VOLTAGE	AC 100V-260V / 130V-250V	
OUTPUT VOITAGE	AC 220V±1~3% 50/60Hz	
DELAY TIME	Short Delay:3-5sec Long Deley:3-7min	
PROTECTION	Over Voltage(246V±4V),Overload,High Temperature,Short Circuit	
POWER	10000VA	15000VA
PRODUCT SIZE(CM)	41.3x28.2x18.1	48.3x35.2x20.7
PACKING SIZE(CM)	46.5x33.2x23.8	53.5×40×29.5
PCS/CARTON	1	1
N.W.(KGS)	23.3	39
G.W.(KGS)	24	44

LED Display



Air Circulation

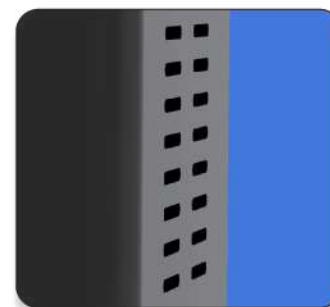

Metal panel

LED-3G

Screen cover

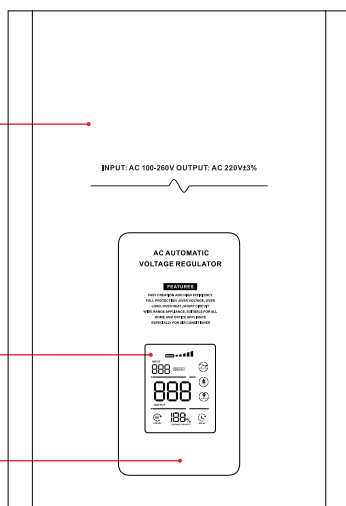

## TECHNICAL DRAWING

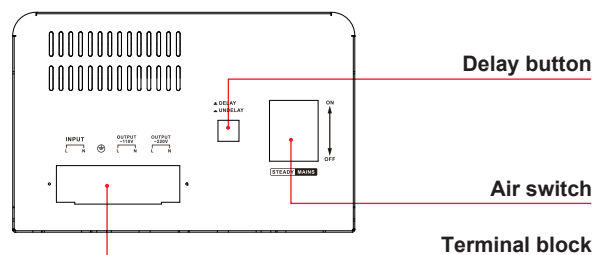

Widely used in various industries, small office equipment, refrigerator, electric fan, computer, pump, air conditioner, etc.



Washing Maching Fridge Air Conditioner Air compressor Motor Water pump

Servo Control + Toroidal Transformer, Efficiency > 97%

# ARS-TVC

Series

(20KVA-30KVA)



ISO9001



The product of this model is a **220V** fully automatic voltage regulator, both for desktop & wall mounted. With LED digital display design. It is characterized by stable work, high pressure regulation speed and wide voltage regulation range.

## TECHNICAL DATA

MODEL	ARS-TVC(20KVA-30KVA)	
INPUT VOLTAGE	AC 100V-260V / 130V-250V	
OUTPUT VOITAGE	AC 220V±1~3% 50/60Hz	
DELAY TIME	Short Delay:3-5sec Long Deley:3-7min	
PROTECTION	Over Voltage(246V±4V),Overload,High Temperature,Short Circuit	
POWER	20000VA	30000VA
PRODUCT SIZE(CM)	38x35x60	40x45x86.5
PACKING SIZE(CM)	45x41x81	51.5x46.5x102
PCS/CARTON	1	1
N.W.(KGS)	65	99
G.W.(KGS)	75	109

LED Display



Colling Fan



LED-3G

Screen cover

Metal panel

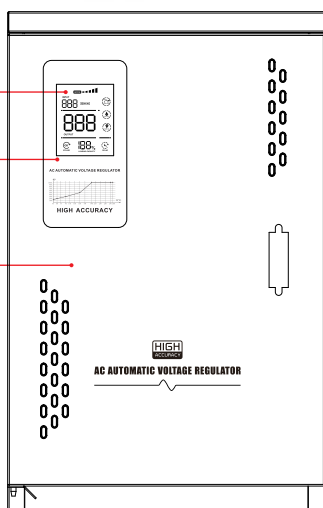

## TECHNICAL DRAWING

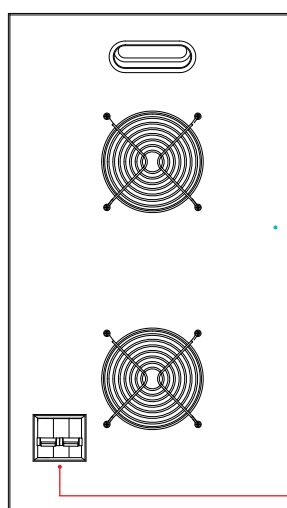

Universal socket

Widely used in various industries, small office equipment, refrigerator, electric fan, computer, pump, air conditioner, etc.



Washing Maching Fridge Air Conditioner Air compressor Motor Water pump

Servo Control + Toroidal Transformer, Efficiency > 97%



# ARS-PC-SVC

Series (3000VA-5000VA)



ISO9001



The product of this model is a high-precision regulator, both for desktop and wall mounted, with LED digital display design, using motor-driven carbon brush sliding between turns of self-coupling transformer winding and directly adjust the output voltage, two kinds of output voltage 110V/220V.

## TECHNICAL DATA

MODEL	ARS-PC-SVC-3KVA
INPUT VOLTAGE	AC 100V-260V / 130V-250V
OUTPUT VOITAGE	AC 220V±1~3% 50/60Hz
DELAY TIME	Short Delay:3-5sec Long Deley:3-7min
PROTECTION	Over Voltage(246V±4V),Overload,High Temperature,Short Circuit
POWER	3000VA
PRODUCT SIZE(CM)	33.5x24.5x15.5
PACKING SIZE(CM)	38.5x33.5x21.2
PCS/CARTON	1
N.W.(KGS)	11.9
G.W.(KGS)	12.3

LED Display



Switch Button



## TECHNICAL DATA

MODEL	ARS-PC-SVC-5KVA
INPUT VOLTAGE	AC 100V-260V / 130V-250V
OUTPUT VOITAGE	AC 220V±1~3% 50/60Hz
DELAY TIME	Short Delay:3-5sec Long Deley:3-7min
PROTECTION	Over Voltage(246V±4V),Overload,High Temperature,Short Circuit
POWER	5000VA
PRODUCT SIZE(CM)	36.5x27x17.5
PACKING SIZE(CM)	41.5x36.5x24.5
PCS/CARTON	1
N.W.(KGS)	17.9
G.W.(KGS)	18.5

Widely used in various industries, small office equipment, refrigerator, electric fan, computer, pump, air conditioner, etc.



Washing Maching Fridge Air Conditioner Air compressor Motor Water pump

Servo Motor Control + Toroidal Transformer, Efficiency > 97%

# ARS-PC-SVC-A

Series (8000VA-15KVA)



ISO9001



The product of this model is a high-precision regulator, both for desktop and wall mounted, with LED digital display design, using motor-driven carbon brush sliding between turns of self-coupling transformer winding and directly adjust the output voltage, two kinds of output voltage 110V/220V.

## TECHNICAL DATA

MODEL	ARS-PC-SVC-A(8000VA-15KVA)			
INPUT VOLTAGE	AC 100V-260V / 130V-250V			
OUTPUT VOITAGE	AC 220V±1~3% 50/60Hz			
DELAY TIME	Short Delay:3-5sec Long Deley:3-7min			
PROTECTION	Over Voltage(246V±4V),Overload,High Temperature,Short Circuit			
POWER	8000VA	10000VA	12000VA	15000VA
PRODUCT SIZE(CM)	42.1x29.8x19.1	42.1x29.8x19.1	48.3x35.2x20.7	48.3x35.2x20.7
PACKING SIZE(CM)	47x35x25	47x35x25	53.5x40x29.5	53.5x40x29.5
PCS/CARTON	1	1	1	1
N.W.(KGS)	21.6	24	30.1	36
G.W.(KGS)	22.6	25	35.1	41

LED Display



Switch Button



Screen cover

LED-3G

Metal panel

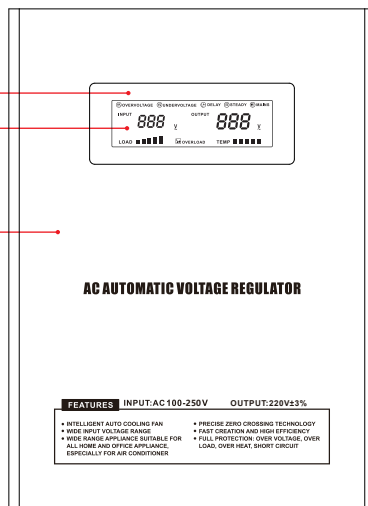

## TECHNICAL DRAWING

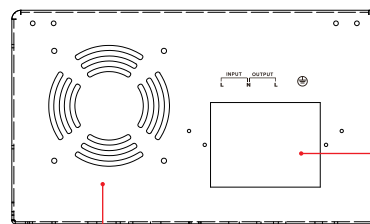

Terminal block

Fan

Widely used in various industries, small office equipment, refrigerator, electric fan, computer, pump, air conditioner, etc.



Servo Motor Control + Toroidal Transformer, Efficiency > 97%

# ARS-F Series

(500VA-1500KVA)



ISO9001



The product of this model is a high-precision regulator, both for desktop and wall mounted, with LED digital display design, using motor-driven carbon brush sliding between turns of self-coupling transformer winding and directly adjust the output voltage. It is characterized by small size, light weight and high-precision output.

## TECHNICAL DATA

MODEL	ARS-F (500VA-1500VA)		
INPUT VOLTAGE	AC 100V-260V		
OUTPUT VOITAGE	AC 220V±1~3% 50/60Hz		
DELAY TIME	Short Delay:3-5sec		
PROTECTION	Over Voltage(246V±4V),Overload,High Temperature,Short Circuit		
POWER	500VA	1000VA	1500VA
PRODUCT SIZE(CM)	30x15.5x20	30x15.5x20	30x15.5x20
PACKING SIZE(CM)	39.5x35x50	39.5x35x50	39.5x35x50
PCS/CARTON	4	4	4
N.W.(KGS)	10.3	13.6	18.9
G.W.(KGS)	12.3	15.8	20.5

LED Display



Power Button



## TECHNICAL DRAWING

Screen sticker

Plastic panel

LED-1B

Indicator light board

Delay button

Switch

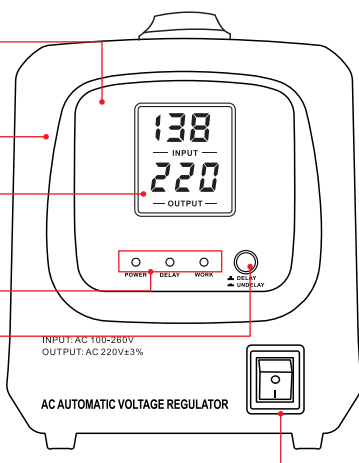

Handle

Five-hole universal socket

Fuse socket

Power cord

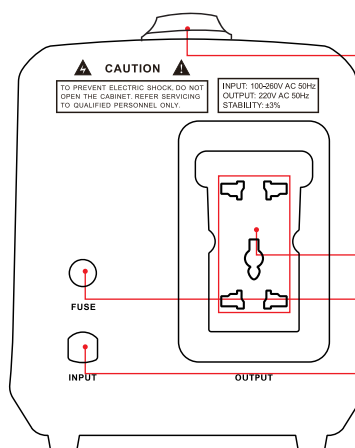

It is widely used in industrial production, scientific research, health care, household appliances which are with large fluctuation of grid voltage or the area with large seasonal grid voltage. It can provide high-quality power to any load.



Washing Maching Fridge Air Conditioner Air compressor Motor Water pump

Servo Control + Toroidal Transformer, Efficiency > 97%

# ARS-F Series

(2000VA-10KVA)



ISO9001



The product of this model is a high-precision regulator, both for desktop and wall mounted, with LCD digital display design, using motor-driven carbon brush sliding between turns of self-coupling transformer winding and directly adjust the output voltage. It is characterized by high-precision output.

## TECHNICAL DATA

MODEL	ARS-F(2000VA-10KVA)				
INPUT VOLTAGE	AC 100V-260V / 130-250V				
OUTPUT VOITAGE	AC 220V±1~3% 50/60Hz				
DELAY TIME	Short Delay:3-5sec				
PROTECTION	Over Voltage(246V±4V),Overload,High Temperature,Short Circuit				
POWER	2000VA	3000VA	5000VA	8000VA	10000VA
PRODUCT SIZE(CM)	28.5x23.7x18.5	30x23x21.5	34.5x22.5x27.3	41.5x24x36	41.5x24x36
PACKING SIZE(CM)	34.5x29x23.5	35.5x28.5x27.5	40x28x34	47x30x42.5	47x30x42.5
PCS/CARTON	1	1	1	1	1
N.W.(KGS)	9.0	12.5	16.5	20.6	27.2
G.W.(KGS)	9.8	13.3	17.3	21.6	28.4

LED Display



Switch Button



## TECHNICAL DRAWING

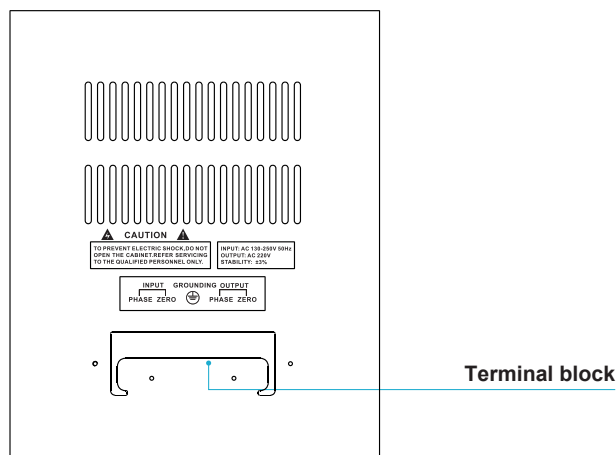
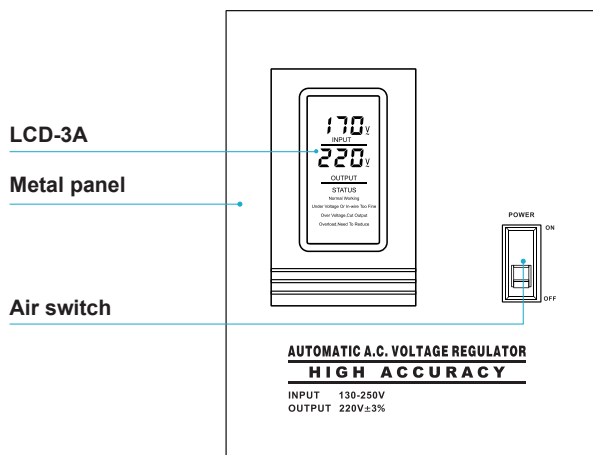

It is widely used in industrial production, scientific research, health care, household appliances which are with large fluctuation of grid voltage or the area with large seasonal grid voltage. It can provide high-quality power to any load.



Servo Motor Control + Toroidal Transformer, Efficiency > 97%

# ARS-SVC50

Series (3000VA-10KVA)



ISO9001



The product of this model is a high-precision regulator, with desktop design, using motor-driven carbon brush sliding between turns of self-coupling transformer winding & directly adjust the output voltage. It is characterized by high-precision output, wide input voltage range.

## TECHNICAL DATA

MODEL	ARS-SVC50(3000VA-10KVA)			
INPUT VOLTAGE	AC 50V-250V / 50V-260V			
OUTPUT VOITAGE	AC 110V / 220V±1~3% 50/60Hz			
DELAY TIME	Short Delay:3-5sec			
PROTECTION	Over Voltage(246V±4V),Overload,High Temperature,Short Circuit			
POWER	3000VA	5000VA	8000VA	10000VA
PRODUCT SIZE(CM)	41x26.5x39	41x26.5x39	43x32x45	43x32x45
PACKING SIZE(CM)	49x32x48	49x32x48	50.5x37.5x44.5	50.5x37.5x44.5
PCS/CARTON	1	1	1	1
N.W.(KGS)	28.3	30.8	34.9	37.7
G.W.(KGS)	35	37.5	41.5	43.6

LED Display



Switch Button



## TECHNICAL DRAWING

LED-2B

Metal panel

Air switch

Universal socket

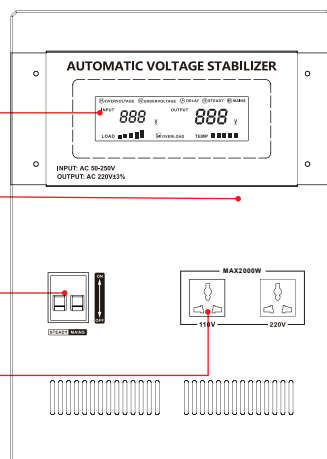

Fan

Terminal block

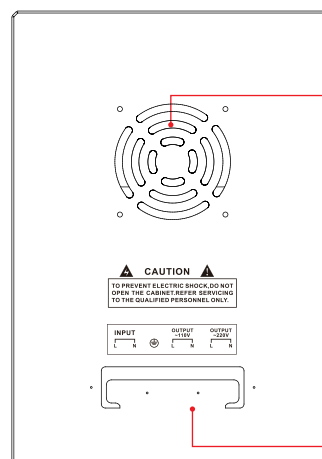

Widely used in various industries, small office equipment, refrigerator, electric fan, computer, pump, air conditioner and other household appliances.



Washing Maching LCD TV Rice Cooker Microwave Oven Printer Computer

Servo Motor Control + Toroidal Transformer, Efficiency > 97%

# ARS-SVC-M

Series (1000VA-1500VA)



ISO9001



The product of this model is a high-precision regulator, with LED digital display design, using motor-driven carbon brush sliding between turns of self-coupling transformer winding and directly adjust the output voltage. It is characterized by small size, light weight and high-precision output.

## TECHNICAL DATA

MODEL	ARS-SVC-M(500VA-1500VA)		
INPUT VOLTAGE	AC 100V-260V / 130V-250V		
OUTPUT VOITAGE	AC 220V±1~3% 50/60Hz		
DELAY TIME	Short Delay:3-5sec Long Deley:3-7min		
PROTECTION	Over Voltage(246V±4V),Overload,High Temperature,Short Circuit		
POWER	500VA	1000VA	1500VA
PRODUCT SIZE(CM)	25.5x11x16	28.5x15x19	28.5x15x19
PACKING SIZE(CM)	63.2x31.5x39	60x33x45	60x33x45
PCS/CARTON	8	6	6
N.W.(KGS)	21.9	23.6	30.2
G.W.(KGS)	22	26.2	33

LED Display



Power Button



## TECHNICAL DRAWING

Metal panel

LED-4B

Screen cover

Delay button

Switch

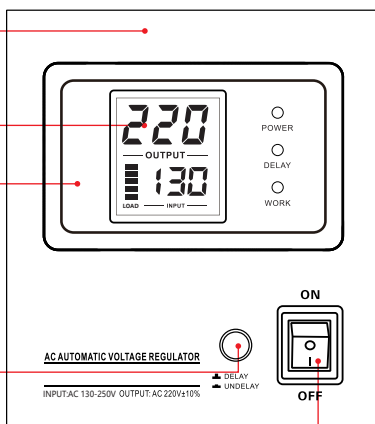

CAUTION  
TO PREVENT ELECTRIC SHOCK, DO NOT OPEN THE CABINET. REFER SERVICING TO QUALIFIED PERSONNEL ONLY.

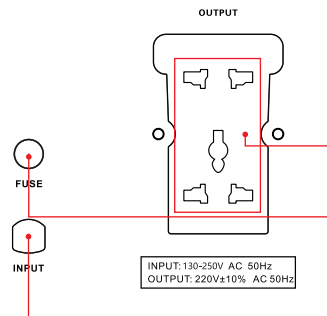

Five-hole universal socket

Fuse socket

Power cord

It is widely used in industrial production, scientific research, health care, household appliances which are with large fluctuation of grid voltage or the area with large seasonal grid voltage. It can provide high-quality power to any load.



Servo Motor Control + Toroidal Transformer, Efficiency > 97%

# ARS-SVC-M

Series

(2000VA-10KVA)



ISO9001



The product of this model is a high-precision regulator, both for desktop and wall mounted, with LED/LCD digital display design, using motor-driven carbon brush sliding between turns of self-coupling transformer winding and directly adjust the output voltage. It is characterized by high-precision output.

## TECHNICAL DATA

MODEL	ARS-SVC-M(2000VA-10KVA)				
INPUT VOLTAGE	AC 100V-260V / 130-250V				
OUTPUT VOITAGE	AC 220V±1~3% 50/60Hz				
DELAY TIME	Short Delay:3-5sec				
PROTECTION	Over Voltage(246V±4V),Overload,High Temperature,Short Circuit				
POWER	2000VA	3000VA	5000VA	8000VA	10000VA
PRODUCT SIZE(CM)	28.5x23.7x18.5	30x23x21.5	34.5x22.5x27.3	41.5x24x36	41.5x24x36
PACKING SIZE(CM)	34.5x29x23.5	35.5x28.5x27.5	40x28x34	47x30x42.5	47x30x42.5
PCS/CARTON	1	1	1	1	1
N.W.(KGS)	9.0	12.5	16.3	20.6	27.0
G.W.(KGS)	9.8	13.3	17.1	21.6	28.0

LED Display



Switch Button



## TECHNICAL DRAWING

Metal panel

LED-2B

Screen sticker

Air switch

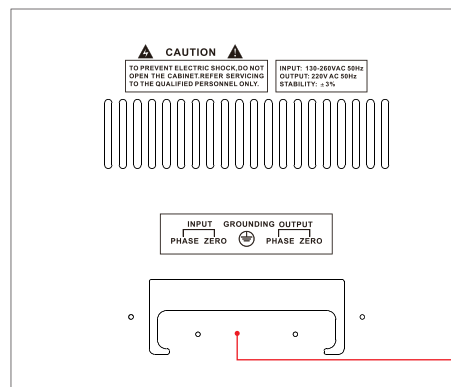
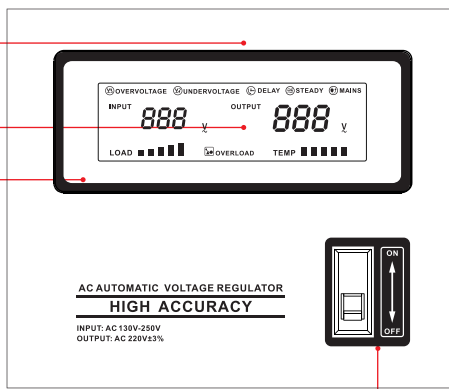

Terminal block

It is widely used in industrial production, scientific research, health care, household appliances which are with large fluctuation of grid voltage or the area with large seasonal grid voltage. It can provide high-quality power to any load.



Washing Maching LCD TV Rice Cooker Microwave Oven Printer Computer

Servo Control + Toroidal Transformer, Efficiency > 97%

# ARS-SVC-X

Series

(15KVA)



ISO9001



The product of this model is a high-precision regulator, both for desktop and wall mounted, with LED/LCD digital display design, using motor-driven carbon brush sliding between turns of self-coupling transformer winding and directly adjust the output voltage. It is characterized by high-precision output.

## TECHNICAL DATA

MODEL	ARS-SVC-X(15KVA)
INPUT VOLTAGE	AC 100V-260V / 130-250V
OUTPUT VOITAGE	AC 220V±1~3% 50/60Hz
DELAY TIME	Short Delay:3-5sec
PROTECTION	Over Voltage(246V±4V),Overload,High Temperature,Short Circuit
POWER	15000VA
PRODUCT SIZE(CM)	37.5x39x43.5
PACKING SIZE(CM)	43.5x45.5x51.5
PCS/CARTON	1
N.W.(KGS)	36.0
G.W.(KGS)	42.4

LED Display



Switch Button



## TECHNICAL DRAWING

Metal panel

LED-3G

Screen cover

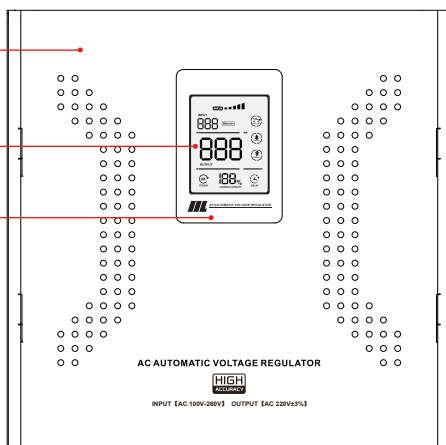

Delay button

Air switch

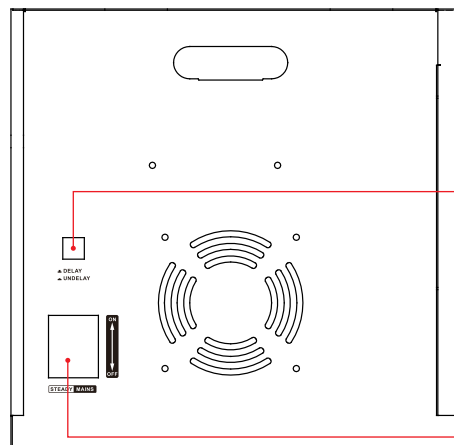

It is widely used in industrial production, scientific research, health care, household appliances which are with large fluctuation of grid voltage or the area with large seasonal grid voltage. It can provide high-quality power to any load.



Washing Maching Fridge Air Conditioner Air compressor Motor Water pump

Servo Control + Toroidal Transformer, Efficiency > 97%



# ARS-SVC-H

Series

(12KVA-15KVA)



ISO9001



The product of this model is a high-precision regulator, both for desktop and wall mounted, with LED/LCD digital display design, using motor-driven carbon brush sliding between turns of self-coupling transformer winding and directly adjust the output voltage. It is characterized by high-precision output.

## TECHNICAL DATA

MODEL	ARS-SVC-H(12KVA-15KVA)	
INPUT VOLTAGE	AC 100V-260V	
OUTPUT VOITAGE	AC 220V±1~3% 50/60Hz	
DELAY TIME	Short Delay:3-5sec	
PROTECTION	Over Voltage(246V±4V),Overload,High Temperature,Short Circuit	
POWER	12000VA	15000VA
PRODUCT SIZE(CM)	39x35x35	39x35x35
PACKING SIZE(CM)	45x41x49.5	45x41x49.5
PCS/CARTON	1	1
N.W.(KGS)	33	35
G.W.(KGS)	39	41

LED Display



Switch Button



## TECHNICAL DRAWING

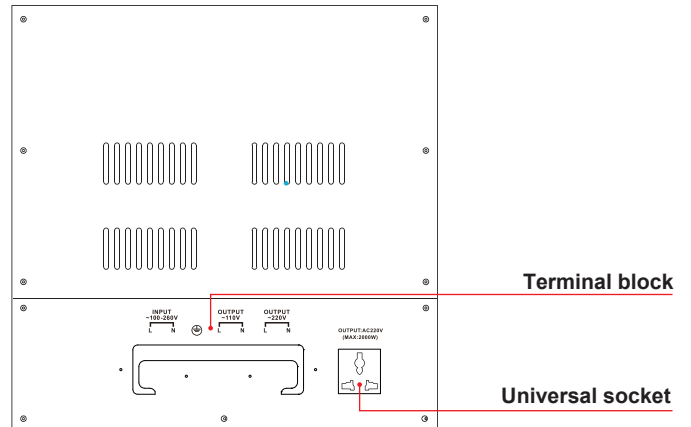
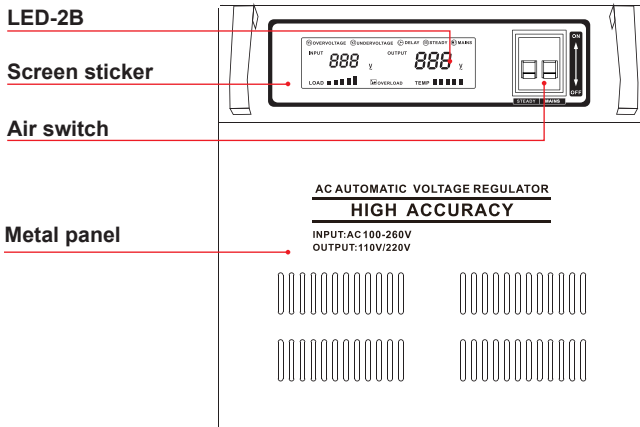

It is widely used in industrial production, scientific research, health care, household appliances which are with large fluctuation of grid voltage or the area with large seasonal grid voltage. It can provide high-quality power to any load.



Servo Control + Toroidal Transformer, Efficiency > 97%

# ARS-TAD

Series

(20KVA-40KVA)



ISO9001



The product of this model is a high-precision regulator, both for desktop and wall mounted, with LED/LCD digital display design, using motor-driven carbon brush sliding between turns of self-coupling transformer winding and directly adjust the output voltage. It is characterized by high-precision output.

## TECHNICAL DATA

MODEL	ARS-TAD(20KVA-40KVA)			
INPUT VOLTAGE	AC 80V-260V / 100V-260V / 130-260V			
OUTPUT VOITAGE	AC 220V±1-3% 50/60Hz			
DELAY TIME	Short Delay:3-5sec			
PROTECTION	Over Voltage(246V±4V),Overload,High Temperature,Short Circuit			
POWER	20000VA(130-260V)	20000VA	30000VA	40000VA
PRODUCT SIZE(CM)	38x35x66.5	45x50x96.5	45x50x96.5	50x55x110
PACKING SIZE(CM)	44x40x75	56x51x103	56x51x103	61x56x126
PCS/CARTON	1	1	1	1
N.W.(KG)	62	103	137	165
G.W.(KG)	68	113	147	176

LED Display



Switch Button



## TECHNICAL DRAWING

LED-3G

Metal panel

Screen cover

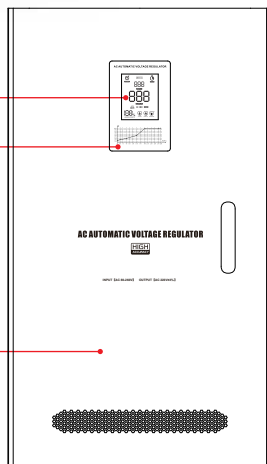

LED-3G

Metal panel

Screen cover

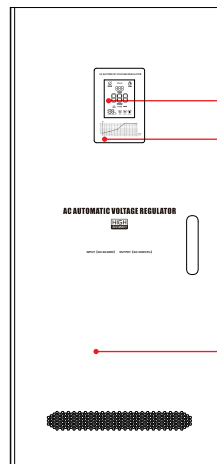

It is widely used in industrial production, scientific research, health care, household appliances which are with large fluctuation of grid voltage or the area with large seasonal grid voltage. It can provide high-quality power to any load.



Washing Maching Fridge Air Conditioner Air compressor Motor Water pump

Servo Control + Toroidal Transformer, Efficiency > 97%

# ARS-TCD

Series

(20KVA-30KVA)



It is widely used in industrial production, scientific research, health care, household appliances which are with large fluctuation of grid voltage or the area with large seasonal grid voltage. It can provide high-quality power to any load.

ISO9001



The product of this model is a high-precision regulator, both for desktop and wall mounted, with LED/LCD digital display design, using motor-driven carbon brush sliding between turns of self-coupling transformer winding and directly adjust the output voltage. It is characterized by high-precision output.

## TECHNICAL DATA

MODEL	ARS-TCD(20KVA-30KVA)	
INPUT VOLTAGE	AC 110V-250V	
OUTPUT VOITAGE	AC 220V±1~3% 50/60Hz	
DELAY TIME	Short Delay:3-5sec	
PROTECTION	Over Voltage(246V±4V),Overload,High Temperature,Short Circuit	
POWER	20000VA	30000VA
PRODUCT SIZE(CM)	38x35x66.5	40x45x94.7
PACKING SIZE(CM)	44x40x75	51.5x46.5x104
PCS/CARTON	1	1
N.W.(KG)	62	137
G.W.(KG)	68	147

LED Display



Cooling Fan



## TECHNICAL DRAWING

LED-3B

Door Lock

Universal Wheel

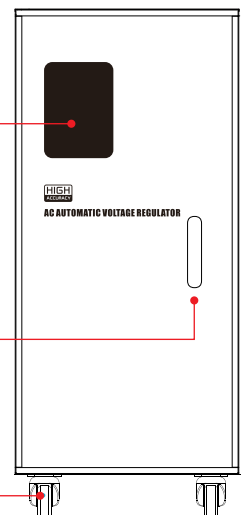

Servo Motor Control + Toroidal Transformer, Efficiency > 97%

# ARS-TCD-A

Series (20KVA-30KVA)



- 
- 
- 

It is widely used in industrial production, scientific research, health care, household appliances which are with large fluctuation of grid voltage or the area with large seasonal grid voltage. It can provide high-quality power to any load.

ISO9001



The product of this model is a high-precision regulator, both for desktop and wall mounted, with LED/LCD digital display design, using motor-driven carbon brush sliding between turns of self-coupling transformer winding and directly adjust the output voltage. It is characterized by high-precision output.

## TECHNICAL DATA

MODEL	ARS-TCD-A(20KVA-30KVA)	
INPUT VOLTAGE	AC 110V-250V	
OUTPUT VOITAGE	AC 220V±1~3% 50/60Hz	
DELAY TIME	Short Delay:3-5sec	
PROTECTION	Over Voltage(246V±4V),Overload,High Temperature,Short Circuit	
POWER	20000VA	30000VA
PRODUCT SIZE(CM)	38x35x66.5	40x45x94.7
PACKING SIZE(CM)	44x40x75	51.5x46.5x104
PCS/CARTON	1	1
N.W.(KG)	62	137
G.W.(KG)	68	147

LED Display



Cooling Fan



## TECHNICAL DRAWING

LED-3G

Door Lock

Universal Wheel

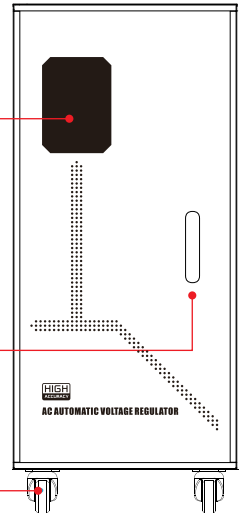

Servo Motor Control + Toroidal Transformer, Efficiency > 97%

# ARS-TND

Series (10KVA-20KVA)

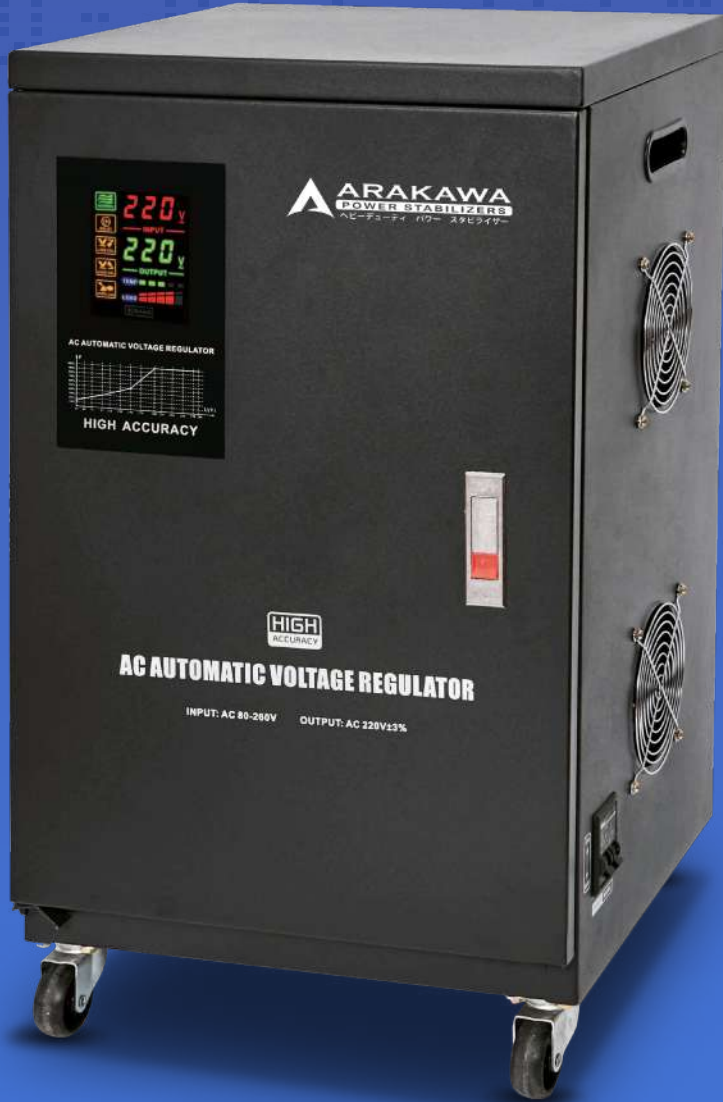

**HIGH ACCURACY**

**SINGLE PHASE**

It is widely used in industrial and mining enterprises, printing, machine tools, post and telecommunications, railways, construction sites, schools, hospitals, hotels, defense, scientific research and other departments of electronic computers, precision machine tools, precision instruments, experimental devices, Elevators and production lines all places where voltage stability is required.

ISO9001



The product of this model is a high-precision regulator, cabinet type with LED digital display design. It is mainly composed of voltage regulation transformer and compensation transformer and characterized by sufficient power, can achieve relatively large power and maintain high-precision output.

## TECHNICAL DATA

MODEL	ARS-TND(10KVA-20KVA)		
INPUT VOLTAGE	AC 80V-260V / 100V-260V / 130-260V		
OUTPUT VOITAGE	AC 220V±1~3% 50/60Hz		
DELAY TIME	Short Delay:3-5sec		
PROTECTION	Over Voltage(246V±4V),Overload,High Temperature,Short Circuit		
POWER	10000VA	15000VA	20000VA
PRODUCT SIZE(CM)	38x35x66.5	38x35x66.5	38x35x66.5
PACKING SIZE(CM)	44x40x75	44x40x75	44x40x75
PCS/CARTON	1	1	1
N.W.(KG)	60.7	62	63
G.W.(KG)	66.7	68	69

LED Display



Cooling Fan



## TECHNICAL DRAWING

LED-3B

Screen cover

Door lock

Universal wheel

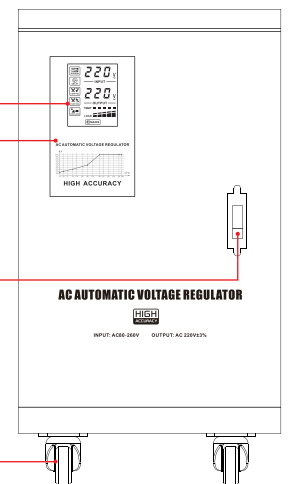

Servo Motor Control + Toroidal Transformer, Efficiency > 97%

# ARS-TND

Series

(20KVA-50KVA)



**HIGH ACCURACY**

**SINGLE PHASE**



It is widely used in industrial and mining enterprises, printing, machine tools, post and telecommunications, railways, construction sites, schools, hospitals, hotels, defense, scientific research and other departments of electronic computers, precision machine tools, precision instruments, experimental devices, Elevators and production lines all places where voltage stability is required.

ISO9001



The product of this model is a high-precision regulator, cabinet type with LED digital display design. It is mainly composed of voltage regulation transformer and compensation transformer and characterized by sufficient power, can achieve relatively large power and maintain high-precision output.

## TECHNICAL DATA

MODEL	ARS-TND(20KVA-50KVA)			
INPUT VOLTAGE	AC 80V-260V / 100V-260V / 130-260V			
OUTPUT VOITAGE	AC 220V±1-3% 50/60Hz			
DELAY TIME	Short Delay:3-5sec			
PROTECTION	Over Voltage(246V±4V),Overload,High Temperature,Short Circuit			
POWER	20000VA	30000VA	40000VA	50000VA
PRODUCT SIZE(CM)	45x50x96.5	45x50x96.5	55x50x116.5	55x50x116.5
PACKING SIZE(CM)	56x51x103	56x51x103	61.5x56x123	61.5x56x123
PCS/CARTON	1	1	1	1
N.W.(KG)	103	137	165	179
G.W.(KG)	113	147	176	190

LED Display



Cooling Fan



## TECHNICAL DRAWING

**LED-3B**  
Screen cover  
Dash board

Air switch

Universal wheel

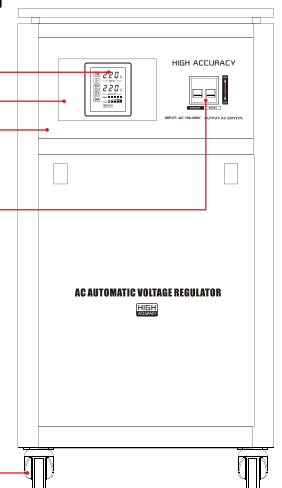

Servo Motor Control + Toroidal Transformer, Efficiency > 97%

# ARS-TND-A

Series

(50KVA)



**HIGH ACCURACY**

**SINGLE PHASE**



It is widely used in industrial and mining enterprises, printing, machine tools, post and telecommunications, railways, construction sites, schools, hospitals, hotels, defense, scientific research and other departments of electronic computers, precision machine tools, precision instruments, experimental devices, Elevators and production lines all places where voltage stability is required.

ISO9001



The product of this model is a high-precision regulator, cabinet type with LED digital display design. It is mainly composed of voltage regulation transformer and compensation transformer and characterized by sufficient power, can achieve relatively large power and maintain high-precision output.

## TECHNICAL DATA

MODEL	ARS-TND-A(50KVA)
INPUT VOLTAGE	AC 80V-260V / 100V-260V / 130-260V
OUTPUT VOITAGE	AC 220V±1~3% 50/60Hz
DELAY TIME	Short Delay:3-5sec
PROTECTION	Over Voltage(246V±4V),Overload,High Temperature,Short Circuit
POWER	50000VA
PRODUCT SIZE(CM)	55x50x116.5
PACKING SIZE(CM)	61.5x56x123
PCS/CARTON	1
N.W.(KG)	179
G.W.(KG)	190

LED Display



Door Lock

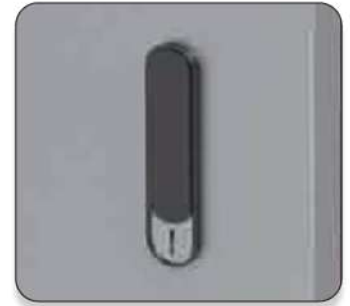

## TECHNICAL DRAWING

LED-3G

Door Lock

Universal Wheel

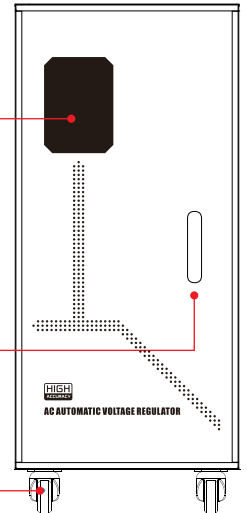

Washing Maching Fridge Air Conditioner Air compressor Motor Water pump

Servo Motor Control + Toroidal Transformer, Efficiency > 97%

# ARS-P Series

(9KVA-30KVA)



**HIGH ACCURACY**

## THREE PHASE

It is widely used in industrial and mining enterprises, printing, machine tools, post and telecommunications, railways, construction sites, schools, hospitals, hotels, defense, scientific research and other departments of electronic computers, precision machine tools, precision instruments, experimental devices, Elevators and production lines all places where voltage stability is required.

ISO9001

NORMAL

DELAY

LOW VOL

OVER VOL

OVER LOAD

The product of this model is a high-precision regulator, cabinet type design. With single phase voltage regulation. Pointer display/Digital display selection.

### TECHNICAL DATA

MODEL	ARS-P(9KVA-30KVA)			
INPUT VOLTAGE	AC 260V-456V/300V-430V			
OUTPUT VOITAGE	AC 380V±1-3% 50/60Hz			
DELAY TIME	Short Delay:3-5sec			
PROTECTION	Over Voltage,Overload,High Temperature,Short Circuit			
POWER	9000VA	15000VA	20000VA	30000VA
PRODUCT SIZE(CM)	32x40.9x75.4	33.7x41x81.2	37.7x44.1x102	37.7x44.1x102
PACKING SIZE(CM)	38x46.9x83.9	39.7x47x89.7	43.7x50.1x108.5	43.7x50.1x108.5
PCS/CARTON	1	1	1	1
N.W.(KG)	38.6	48	75	101.5
G.W.(KG)	43.7	54	83.5	115.5

LED Display



Universal Wheel



### TECHNICAL DRAWING

Screen cover

Three phase

Door lock

Universal wheel

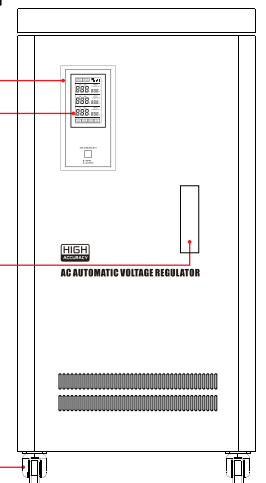

Servo Motor Control + Toroidal Transformer, Efficiency > 97%



# ARS-TNS-C

Series

(9KVA-15KVA)



**HIGH ACCURACY**

## THREE PHASE

It is widely used in industrial and mining enterprises, printing, machine tools, post and telecommunications, railways, construction sites, schools, hospitals, hotels, defense, scientific research and other departments of electronic computers, precision machine tools, precision instruments, experimental devices, Elevators and production lines all places where voltage stability is required.

ISO9001



The product of this model is a high-precision regulator, cabinet type design. With single phase voltage regulation. Pointer display/Digital display selection.

### TECHNICAL DATA

MODEL	ARS-TNS-C(9KVA-15KVA)	
INPUT VOLTAGE	AC 260V-456V/300V-430V	
OUTPUT VOITAGE	AC 380V±1~3% 50/60Hz	
DELAY TIME	Short Delay:3-5sec	
PROTECTION	Over Voltage,Overload,High Temperature,Short Circuit	
POWER	9000VA	15000VA
PRODUCT SIZE(CM)	32x41.5x75.4	33.7x41.5x81.2
PACKING SIZE(CM)	38x46.9x83.9	39.7x47x89.7
PCS/CARTON	1	1
N.W.(KG)	38.6	48
G.W.(KG)	43.7	54

LED Display



Door Lock



### TECHNICAL DRAWING

Screen cover

Three phase

Door lock

Universal wheel

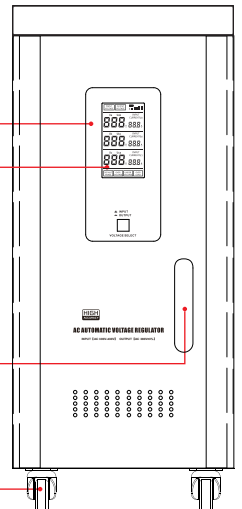

Washing Maching Fridge Air Conditioner Air compressor Motor Water pump

Servo Motor Control + Toroidal Transformer, Efficiency > 97%

# ARS-TNS-C

Series

(20KVA-30KVA)



**HIGH ACCURACY**

**THREE PHASE**

It is widely used in industrial and mining enterprises, printing, machine tools, post and telecommunications, railways, construction sites, schools, hospitals, hotels, defense, scientific research and other departments of electronic computers, precision machine tools, precision instruments, experimental devices, Elevators and production lines all places where voltage stability is required.

ISO9001

NORMAL DELAY LOW VOL OVER VOL OVER LOAD

The product of this model is a high-precision regulator, cabinet type design. With single phase voltage regulation. Pointer display/Digital display selection.

### TECHNICAL DATA

MODEL	ARS-TNS-C(20KVA-30KVA)	
INPUT VOLTAGE	AC 260V-456V/300V-430V	
OUTPUT VOITAGE	AC 380V±1~3% 50/60Hz	
DELAY TIME	Short Delay:3-5sec	
PROTECTION	Over Voltage,Overload,High Temperature,Short Circuit	
POWER	20000VA	30000VA
PRODUCT SIZE(CM)	37.7x44.7x102	37.7x44.7x102
PACKING SIZE(CM)	43.7x50.1x108.5	43.7x50.1x108.5
PCS/CARTON	1	1
N.W.(KG)	75	101.5
G.W.(KG)	83.5	115.5

LED Display



Door Lock



### TECHNICAL DRAWING

Screen cover

Three phase

Door lock

Universal wheel

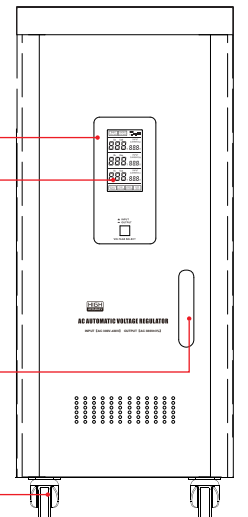

Servo Motor Control + Toroidal Transformer, Efficiency > 97%

# ARS-TNS-U

Series

(9KVA-15KVA)



**HIGH ACCURACY**

**THREE PHASE**

It is widely used in industrial and mining enterprises, printing, machine tools, post and telecommunications, railways, construction sites, schools, hospitals, hotels, defense, scientific research and other departments of electronic computers, precision machine tools, precision instruments, experimental devices, Elevators and production lines all places where voltage stability is required.

ISO9001

NORMAL DELAY LOW VOL OVER VOL OVER LOAD

The product of this model is a high-precision regulator, cabinet type design. With single phase voltage regulation. Pointer display/Digital display selection.

**TECHNICAL DATA**

MODEL	TNS-U(9KVA-15KVA)	
INPUT VOLTAGE	AC 260V-456V/300V-430V	
OUTPUT VOITAGE	AC 380V±1~3% 50/60Hz	
DELAY TIME	Short Delay:3-5sec	
PROTECTION	Over Voltage,Overload,High Temperature,Short Circuit	
POWER	9000VA	15000VA
PRODUCT SIZE(CM)	32x41.5x75.4	33.7x41.5x81.2
PACKING SIZE(CM)	38x46.9x83.9	39.7x47x89.7
PCS/CARTON	1	1
N.W.(KG)	38.6	48
G.W.(KG)	43.7	54

LED Display



Door Lock



**TECHNICAL DRAWING**

- Three phase
- Screen cover
- Door lock
- Universal wheel

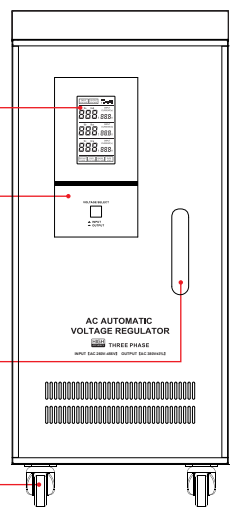

Servo Motor Control + Toroidal Transformer, Efficiency > 97%

# ARS-TNS-U

Series

(20KVA-30KVA)



**HIGH ACCURACY**

## THREE PHASE

It is widely used in industrial and mining enterprises, printing, machine tools, post and telecommunications, railways, construction sites, schools, hospitals, hotels, defense, scientific research and other departments of electronic computers, precision machine tools, precision instruments, experimental devices, Elevators and production lines all places where voltage stability is required.

ISO9001



The product of this model is a high-precision regulator, cabinet type design. With single phase voltage regulation. Pointer display/Digital display selection.

### TECHNICAL DATA

MODEL	ARS-TNS-U(20KVA-30KVA)	
INPUT VOLTAGE	AC 260V-456V/300V-430V	
OUTPUT VOITAGE	AC 380V±1~3% 50/60Hz	
DELAY TIME	Short Delay:3-5sec	
PROTECTION	Over Voltage,Overload,High Temperature,Short Circuit	
POWER	20000VA	30000VA
PRODUCT SIZE(CM)	37.7x44.7x102	37.7x44.7x102
PACKING SIZE(CM)	43.7x50.1x108.5	43.7x50.1x108.5
PCS/CARTON	1	1
N.W.(KG)	75	101.5
G.W.(KG)	83.5	115.5

LED Display



Door Lock



### TECHNICAL DRAWING

Three phase

Screen cover

Door lock

Universal wheel

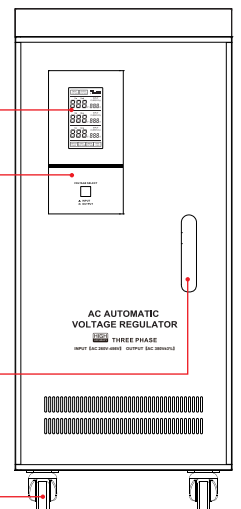

Servo Motor Control + Toroidal Transformer, Efficiency > 97%

# ARS-TNSB

Series

(15KVA-60KVA)



**HIGH ACCURACY**

## THREE PHASE

It is widely used in industrial and mining enterprises, printing, machine tools, post and telecommunications, railways, construction sites, schools, hospitals, hotels, defense, scientific research and other departments of electronic computers, precision machine tools, precision instruments, experimental devices, Elevators and production lines all places where voltage stability is required.

ISO9001



Three phase compensation high-precision regulator, cabinet type with LED digital display design, compensated structure voltage regulation. It is mainly composed of voltage regulation transformer and compensation transformer & characterized by sufficient power, can achieve relatively large power & maintain high-precision output.

### TECHNICAL DATA

MODEL	ARS-TNSB(15KVA-60KVA)					
INPUT VOLTAGE	AC 260V-456V/300V-430V					
OUTPUT VOITAGE	AC 380V±1~3% 50/60Hz					
DELAY TIME	Short Delay:3-5sec					
PROTECTION	Over Voltage,Overload,High Temperature,Short Circuit					
POWER	15000VA	20000VA	30000VA	40000VA	50000VA	60000VA
PRODUCT SIZE(CM)	48.5x49.5x100		59.5x49x111		75x63x136	
PACKING SIZE(CM)	55.5x55x103		66x55.5x134		84.5x72.5x144	
PCS/CARTON	1	1	1	1	1	1
N.W.(KG)	86	108.5	125	170	190	196
G.W.(KG)	94	116.5	135	183	203	209

LED Display



Door Lock



### TECHNICAL DRAWING

Screen cover

Three phase

Delay button

Door lock

Universal wheel

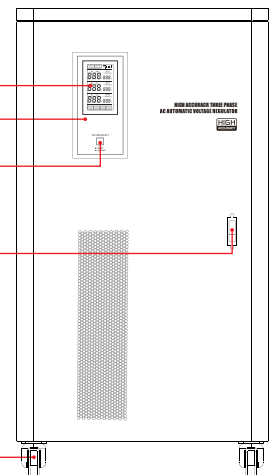

Washing Maching Fridge Air Conditioner Air compressor Motor Water pump

Servo Motor Control + Toroidal Transformer, Efficiency > 97%

# ARS-TNSB-A

Series

(40KVA-50KVA)



**HIGH ACCURACY**

## THREE PHASE

It is widely used in industrial and mining enterprises, printing, machine tools, post and telecommunications, railways, construction sites, schools, hospitals, hotels, defense, scientific research and other departments of electronic computers, precision machine tools, precision instruments, experimental devices, Elevators and production lines all places where voltage stability is required.

ISO9001



Three phase compensation high-precision regulator, cabinet type with LED digital display design, compensated structure voltage regulation. It is mainly composed of voltage regulation transformer and compensation transformer & characterized by sufficient power, can achieve relatively large power & maintain high-precision output.

### TECHNICAL DATA

MODEL	ARS-TNSB-A(40KVA-50KVA)	
INPUT VOLTAGE	AC 260V-456V/300V-430V	
OUTPUT VOITAGE	AC 380V±1~3% 50/60Hz	
DELAY TIME	Short Delay:3-5sec	
PROTECTION	Over Voltage,Overload,High Temperature,Short Circuit	
POWER	40000VA	50000VA
PRODUCT SIZE(CM)	59.5x49x111	75x63x136
PACKING SIZE(CM)	66x55.5x134	84.5x72.5x144
PCS/CARTON	1	1
N.W.(KG)	170	190
G.W.(KG)	183	203

LED Display



Door Lock

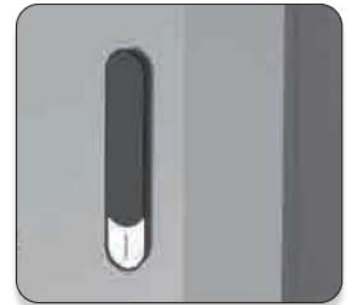

### TECHNICAL DRAWING

Screen cover

Three phase

Door lock

Universal wheel

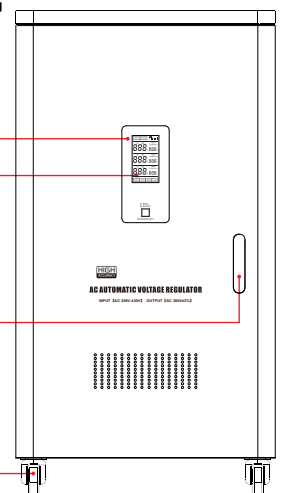

Washing Maching Fridge Air Conditioner Air compressor Motor Water pump

Servo Motor Control + Toroidal Transformer, Efficiency > 97%

# ARS-TNSB-U

Series

(40KVA-50KVA)



**HIGH ACCURACY**

## THREE PHASE

It is widely used in industrial and mining enterprises, printing, machine tools, post and telecommunications, railways, construction sites, schools, hospitals, hotels, defense, scientific research and other departments of electronic computers, precision machine tools, precision instruments, experimental devices, Elevators and production lines all places where voltage stability is required.

ISO9001



Three phase compensation high-precision regulator, cabinet type with LED digital display design, compensated structure voltage regulation. It is mainly composed of voltage regulation transformer and compensation transformer & characterized by sufficient power, can achieve relatively large power & maintain high-precision output.

### TECHNICAL DATA

MODEL	ARS-TNSB-U(40KVA-50KVA)	
INPUT VOLTAGE	AC 260V-456V/300V-430V	
OUTPUT VOITAGE	AC 380V±1~3% 50/60Hz	
DELAY TIME	Short Delay:3-5sec	
PROTECTION	Over Voltage,Overload,High Temperature,Short Circuit	
POWER	40000VA	50000VA
PRODUCT SIZE(CM)	59.5x49x111	75x63x136
PACKING SIZE(CM)	66x55.5x134	84.5x72.5x144
PCS/CARTON	1	1
N.W.(KG)	170	190
G.W.(KG)	183	203

LED Display



Door Lock



### TECHNICAL DRAWING

Three phase

Screen cover

Door lock

Universal wheel

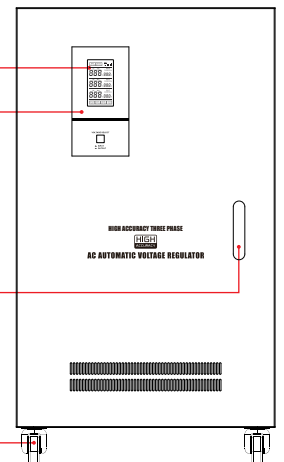

Servo Motor Control + Toroidal Transformer, Efficiency > 97%

# ARS-PD Series

(50KVA-2000KVA)



**HIGH ACCURACY** THREE PHASE **Pointer Style**



**HIGH ACCURACY** THREE PHASE **LED Style**

ISO9001



The product of this model is cabinet type design, pointer display/digital display selection. It is characterized high-precision output. Suitable for a wide range of load, can withstand instantaneous overload. Long-term continuous work can be carried out, manual/ automatic switching and the automatic protection for over voltage, phase loss, phase sequence and mechanical failure are provided.

### TECHNICAL DRAWING

Pointer display

Indicator light board

Door lock

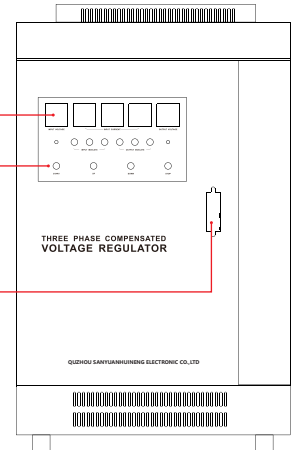

It is widely used in industrial and mining enterprises, printing, machine tools, post and telecommunications, railways, construction sites, schools, hospitals, hotels, defense, scientific research and other departments of electronic computers, precision machine tools, precision instruments, experimental devices, Elevators and production lines all places where voltage stability is required.

### TECHNICAL DRAWING

Pointer display

Indicator light board

Door lock

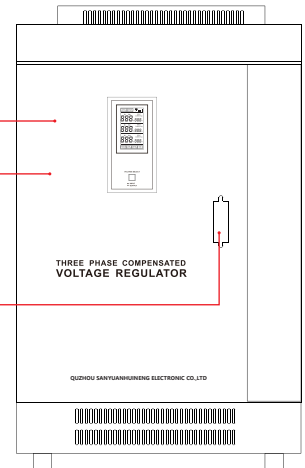

Servo Motor Control + Toroidal Transformer, Efficiency > 97%



# ARS-PD Series

(50KVA-2000KVA)

ISO9001



## SPECIFICATION

Technology	Servo Motor Control+Toroidal Transformer, Efficiency >97%
Input Voltage	175Vac-265Vac (phase voltage) 300Vac-456Vac(line voltage)
Output Voltage	Single phase: 220Vac Three phase:380Vac
Output Accuracy	(1%~5%)
Protection	Over Voltage, Overload, High Temperature, Short Circuit(with fuse or circuit breaker)
Operating Temperature	-20~50°C
Operating Relative Humidity	10%RH-102%RH: non condensing

Model	Packing Size(cm)	G.W.(KGS)	QTY/40FT
ARS-PD-50KVA	90 × 64 × 143	250	64
ARS-PD-60KVA	90 × 64 × 143	255	64
ARS-PD-100KVA	95 × 72 × 159	357	48
ARS-PD-150KVA	95 × 72 × 159	482	48
ARS-PD-200KVA	95 × 72 × 159	562	48
ARS-PD-250KVA	107 × 80 × 180	710	34
ARS-PD-300KVA	110 × 80 × 195	755	28
ARS-PD-320KVA	110 × 80 × 195	810	28
ARS-PD-400KVA	100 × 80 × 200(2cases)	1175	30
ARS-PD-500KVA	100 × 80 × 200(2cases)	1510	30
ARS-PD-600KVA	100 × 80 × 200(2cases)	1790	30
ARS-PD-F800KVA	85 × 110 × 200(3cases)	2750	28
ARS-PD-F1000KVA	85 × 110 × 200(3cases)	2780	28
ARS-PD-F1200KVA	85 × 110 × 200(3cases)	4050	28
ARS-PD-F1600KVA	120 × 120 × 220(4cases)	5500	17
ARS-PD-F2000KVA	130 × 120 × 220(4cases)	7050	15



THREE PHASE



Washing Maching Fridge Air Conditioner Air compressor Motor Water pump

Servo Motor Control + Toroidal Transformer, Efficiency > 97%

# CUSTOM PART

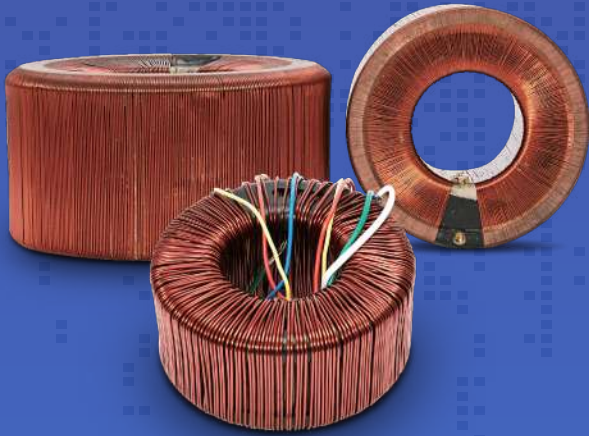

## TOROIDAL TRANSFORMER

The toroidal transformer plays a key role in maintaining a stable voltage level, protecting connected devices from voltage variations and ensuring reliable operation.

## PLUGS

Customized any plugs design from international and specific plugs. Variation and dependable long life plugs with durable and strong material.



ISO9001

NORMAL

DELAY

LOW VOL

OVER VOL

OVER LOAD



## TOROIDAL CORE

To efficiently transfer and transform electrical energy, provide isolation, minimize electromagnetic interference, and contribute to the stability of the output voltage.

## SOCKETS

Customized any sockets design from international and specific sockets. Variation and dependable long life sockets with durable and strong material.



# INDOTARA®

## PT. INDOTARA PERSADA

### Our Marketing Office and After Sales Service Center

#### Head Office

50/F, Menara BCA Grand Indonesia  
Jl. M.H. Thamrin No.1  
Jakarta Pusat 10310

021 - 5011 2227

dee@indotara.id



#### Semarang Office

Wisma HSBC Lt. 6 Suite 609  
Jl. Gajah Mada No.135  
Semarang, Jawa Tengah 50134

024 - 40 300 892

smg.dee@indotara.id



#### Marketing Office

APL Tower 6th Floor No. 6 Central Park,  
Jl. Letjen S. Parman Kav 28,  
Jakarta Barat - 11440

021 - 5011 2227

dee@indotara.id



#### Medan Office

Sutomo Tower Lantai 5H  
Jl. Sutomo Ujung No.28,  
Kota Medan, Sumatera Utara 20235

061 - 50 300 594

mdn.dee@indotara.id



#### Graha Indotara

Millenium Industrial Estate  
Jl. Millenium 22 Blok R3 No. 1  
Cikupa, Tangerang - Banten 15720

021 - 5011 2227

dee@indotara.id



#### Makassar Office

Fajar Graha Pena Lt. 5  
Jl. Urip Sumoharjo No. 20,  
Makassar - South Sulawesi 90234

021 - 5011 2227

mks.dee@indotara.id



#### Bandung Office

Wisma HSBC Lt. 6 Suite B  
Jl. Asia Afrika No. 116  
Bandung, Jawa Barat 40112

021 - 5011 2227

bdg.dee@indotara.id



#### Balikpapan Office

Panin Tower Lt. 8 - Grand Sudirman  
Jl. Jendral Sudirman No.7 Klandasan Ilir,  
Balikpapan Kota, Kalimantan Timur 76114

021 - 5011 2227

bpp.dee@indotara.id



#### Surabaya Office

Japfa Indoland Center, Tower I Lt. 10/1008  
Jl. Jendral Basuki Rahmat 129-137  
Surabaya 60271

031 - 3360 1490

sby.dee@indotara.id



#### Bali Office

Benoa Square Lt. 2  
Jl. Bypass Ngurah Rai No. 21 A Kedonganan,  
Kuta Badung - Bali Indonesia 80361

021 - 5011 2227

bali.dee@indotara.id



#### Yogyakarta Office

Hartono Mall Yogyakarta Lt. 3  
Kaliwaru, Condongcatur,  
Sleman, Yogyakarta 55281

021 - 5011 2227

yog.dee@indotara.id



#### Singapore Office

Marina Bay Financial Centre Tower 3  
17F, 12 Marina Boulevard  
Singapore - 018982

021 - 5011 2227

sing.dee@indotara.id

